

THE *Futurist* EDITION

GO
things

There's more to
Australian
Mining

Produced by the
Minerals Council of Australia

THE *Futurist* EDITION

Minerals Council of Australia

Ph. + 61 2 6233 0600

E. info@minerals.org.au

minerals.org.au



© Minerals Council of Australia

All rights reserved. Apart from any use permitted under the *Copyright Act 1968*, no part of this publication may be reproduced, stored or transmitted in any form without the written permission of the publisher and copyright holders.

30 things

Contents

01	The metaverse	16	3D printing
02	Driverless vehicles	17	Mines of the future
03	Cloud robotics	18	Fusion energy
04	Advanced healthcare	19	Carbon reduction
05	Smart housing	20	Water management
06	Hyper-fast transport	21	Cryonics
07	Food production	22	Flying taxis
08	AR smart phones	23	Supply chain security
09	Renewable energy	24	Advanced nuclear
10	Synthetic virology	25	Digital economy
11	Quantum computing	26	Hydrogen energy
12	Advanced bionics	27	Particle physics
13	Wearable technology	28	Defence systems
14	Deep space astronomy	29	Emergency management
15	Space tourism	30	USS Enterprise

Acronyms

AI	Artificial Intelligence
ANSTO	Australian Nuclear Science and Technology Organisation
AROSE	Australian Remote Operations in Space and on Earth consortium
AR	Augmented Reality
CCS	Carbon Capture and Storage
CERN	European Organization for Nuclear Research
eVTOL	Electric Vertical Take-Off and Landing Aircraft
EV	Electric Vehicles
GIS	Geographic Information Systems
GPS	Global Positioning System
IEA	International Energy Agency
IMF	International Monetary Fund
IoMT	Internet of Military Things
IoT	Internet of Things
ILC	International Linear Collider
IVF	In Vitro Fertilisation
LHC	Large Hadron Collider
ML	Machine Learning
NASA	National Aeronautics and Space Administration
NFT	Non-Fungible Tokens
OG	Original Gangster
SMR	Small Modular Reactor
UAV	Unmanned Aerial Vehicle
UN	United Nations
VR	Virtual Reality

Mining makes the *imaginable* possible



Whatever shape the future takes, Australia's minerals industry will be at the forefront of making the imaginable possible

Australia's minerals industry has underpinned decades of high living standards as the nation's largest exporter, company taxpayer and a significant employer. Parallel to the industry's unrivalled economic contribution is the role mining plays supplying the minerals and metals critical for today's technologies, and tomorrow's.

From cloud robotics to space exploration, quantum computing to advanced bionics, the pace and progress of human advancement will be determined by the technologies made possible by minerals and metals. Minerals like the silicon in next generation augmented reality (AR) electronics, or the neodymium in the permanent magnets that power electric vehicles (EVs), or the copper and nickel in zero emissions energy systems.

Following on from *30 Things*, a guide to the minerals and metals essential for modern life, *30 Things: The Futurist Edition* takes a peek into the future and the raw materials critical to the technologies at our fingertips - and on the cusps of our imaginations.

Many of the emerging technologies explored on these pages will intrigue and fascinate, and some may even give reason for pause. This is equally as important. The onward march of technology requires broad public conversations about what we are prepared to accept, individually and as a society.

But for as many hard conversations, new technologies will increasingly provide solutions to some of the world's most complex social and environmental challenges. Solutions like micro-hybrid robots that clean plastic from our oceans, or early warning sensors that protect against natural disasters. Not to mention we are only one subatomic collision away from unlocking the secrets of the universe, thanks to the minerals-heavy technology powering particle accelerators.

But whatever the future holds, one thing is certain. The world will need more minerals and metals in the future - not less. Global decarbonisation alone will drive demand for lithium, manganese, cobalt, graphite and rare earth elements for a long time to come.

Australian mining is changing, too. The same technologies - AI, AR and VR - are making our industry safer, smarter and more sustainable. And while we have long been recognised as world leaders in innovation, workforce and environmental stewardship, we embark on this next leg of the journey committed to being a responsible and trusted partner as we provide the minerals and metals the world needs into the future.

Tania Constable
Chief Executive Officer
Minerals Council of Australia

Virtual real estate sales topped US\$500 million in 2021, and could be valued in the trillions in a few short years _

Morgan Stanley



Immersive headsets

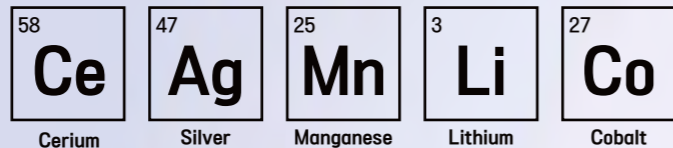

Microphone & speakers

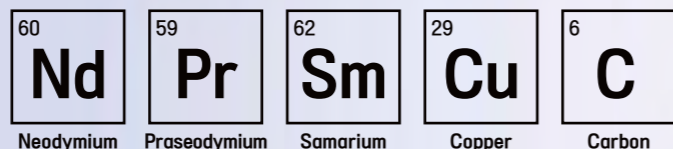

Server farms

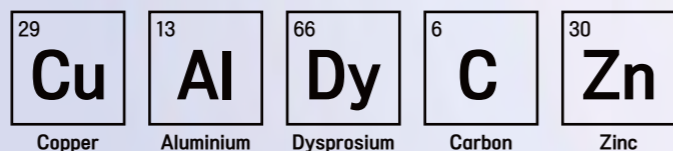

Mobile displays

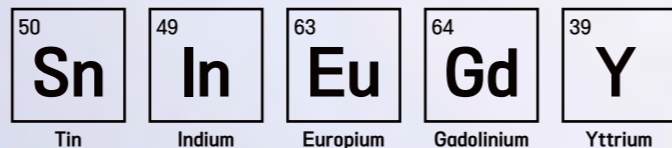

Computer processors

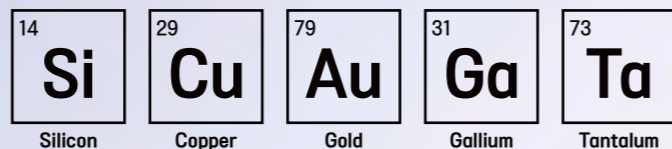

The metaverse (which means *beyond our universe*) is a parallel virtual world with a fully functioning digital economy _

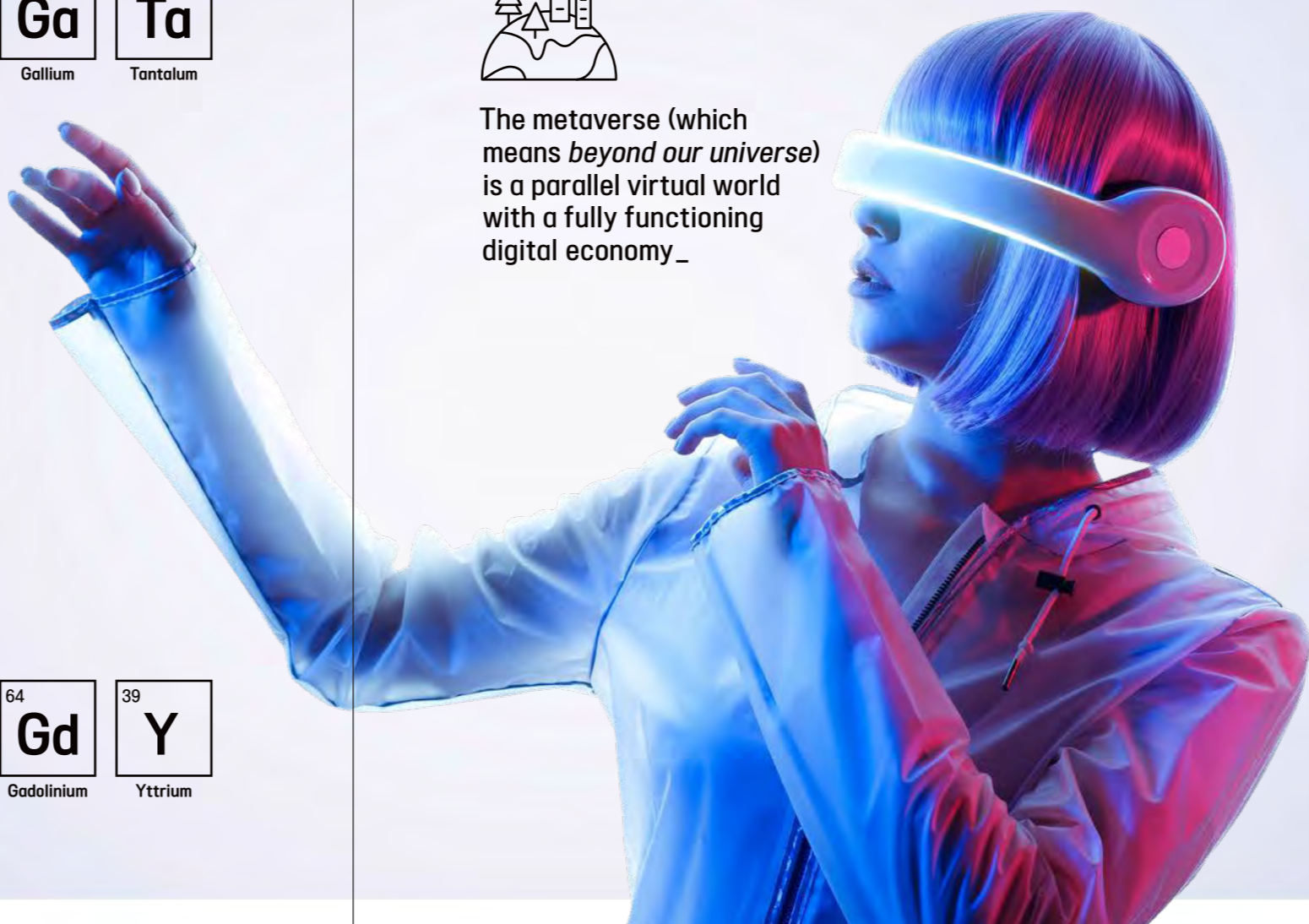

01

The metaverse

Welcome to the metaverse - a network of 3D immersive worlds where real people can live, work and play virtually. From 'holidaying' with distant loved ones to buying 'land' and building on a virtual block to collaborating with colleagues at the virtual office, the metaverse promises to democratise social and economic participation in a massive reimagining of the internet. Tech companies such as Meta, Microsoft and Epic Games are investing billions of dollars in the virtual space, as are high-end brands racing to market to consumers in the digital world. Bloomberg predicts the metaverse will generate revenues of \$800 billion as soon as 2024, largely through video games and live entertainment.

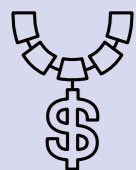

Virtual future for live music

More than 12.3 million people attended the VR Travis Scott concert in *Fortnite* in 2020. The collaboration reportedly grossed the rapper \$20 million, which included the in-concert sale of physical merchandise as well as virtual skins and emotes (dance moves participants can buy for their avatars).

EV batteries

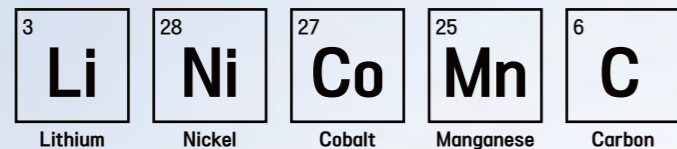

A new lithium-ion battery design could reduce charging time to 10 minutes _
 Pennsylvania State University

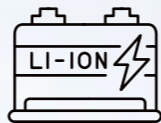

Ultra-resolution cameras

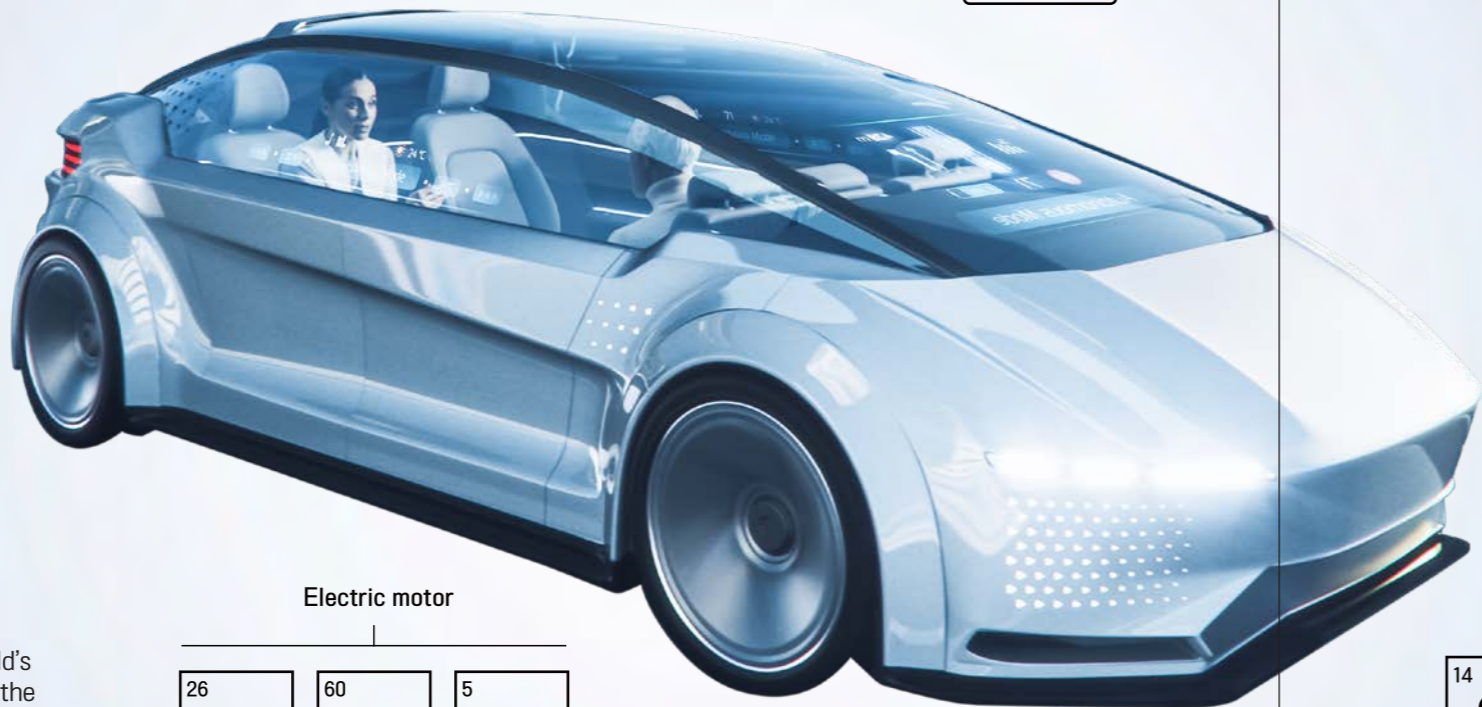
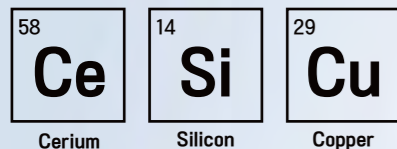

Electric motor

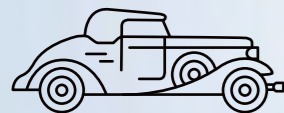
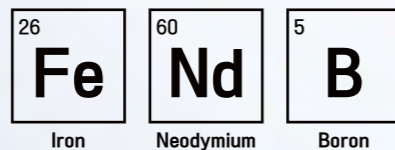

The first autonomous car

General Motors sponsored the world's first known autonomous vehicle at the 1939 New York World Fair. Norman Bel Gedde's Futurama exhibit featured an electric vehicle guided by radio-controlled electromagnetic fields generated by magnetic spikes embedded in the road.

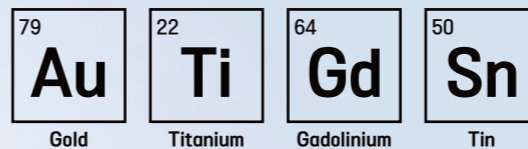

Navigation

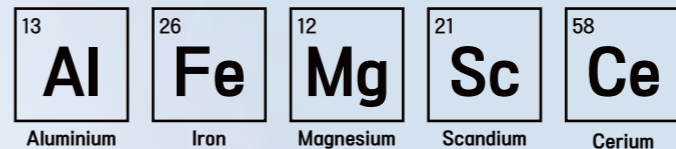

Car body

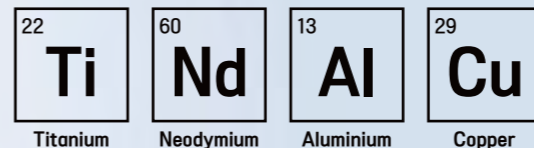

Light-emitting radar (lidar)

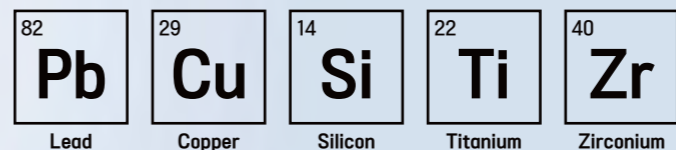

Ultrasonic sensors

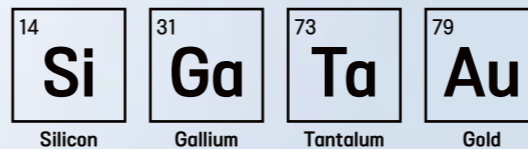

Ultra-fast computer chips

02

Driverless vehicles

While modern cars include self-driving features such as lane detection, parking assist and emergency braking, a truly driverless vehicle - a car requiring no human intervention - is a way off. That doesn't mean companies like General Motors, Tesla and Alphabet aren't committed to the task. In states across America, self-driving vehicles are navigating public roads, giving way to pedestrians and avoiding hazards, generating massive amounts of data for the developers racing to crack the market. With 90 per cent of accidents caused by human error, autonomous cars promise to improve road safety, reduce emissions and ease congestion - but perhaps don't go trading in the family sedan just yet.

An AI system solved the mechanics of a flatworm's regeneration in 42 hours, a mystery that eluded scientists for 100 years.

Tufts University, Massachusetts

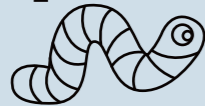

Power source	²⁵ Mn Manganese	²⁸ Ni Nickel	²⁷ Co Cobalt	⁶ C Carbon	²⁹ Cu Copper
Robot frame & shell	¹⁴ Si Silicon	²² Ti Titanium	¹² Mg Magnesium	⁶ C Carbon	²⁶ Fe Iron
Cloud servers	²⁹ Cu Copper	⁴¹ Nb Niobium	⁶⁶ Dy Dysprosium	⁶⁸ Er Erbium	⁵¹ Sb Antimony
CPU (Central Processing Unit)	⁷⁹ Au Gold	³¹ Ga Gallium	¹⁴ Si Silicon	⁴⁷ Ag Silver	⁴⁶ Pd Palladium
Sensors (Displays & speakers)	⁶⁵ Tb Terbium	⁶³ Eu Europium	⁵⁸ Ce Cerium	³⁹ Y Yttrium	⁶⁰ Nd Neodymium

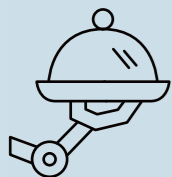

At your service...

Hotel guests are hosted by multilingual humanoid staff at Japan's robot-run Henn na Hotel in Nagasaki. Robots are not a new or strange phenomenon in Japan, with robot coffee vendors, tour guides and even casino croupiers working alongside their flesh and blood colleagues.



Humanoid robot Sophia was named the United Nation's Innovation Champion in 2017 - the first non-human to be given a UN title.

United Nations Development Programme



5G Network

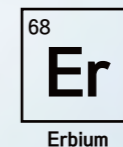
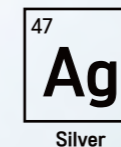
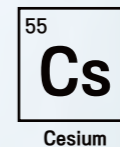

03

Cloud robotics

Robots have traditionally been limited to pre-programmed algorithms, but not for much longer. Cloud robotics combines cloud computing, deep learning, big data and connectivity to create robots that interact and learn from each other in real-time. And if that doesn't evoke dystopian scenes, scientists at Binghamton University in the US have developed a shape-shifting metal that could be the pre-cursor to a liquid metal robot like the T-1000 character from *Terminator 2*. Scientists moulded a liquid metal lattice into the shape of a human hand from bismuth, indium and tin (a compound known as Field's alloy). Encased in a silicon skin, the liquid metal hand can be crushed but returns to its original shape on heating.

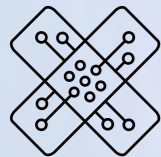

Smart bandages

Scientists at the Technion Israel Institute of Technology have developed a self-healing polymer dressing that closes and supports the healing of wounds. Integrated carbon nanotubes and electrical biosensors monitor for infection, dispense antibiotics and relay the data to a smart phone or other device.

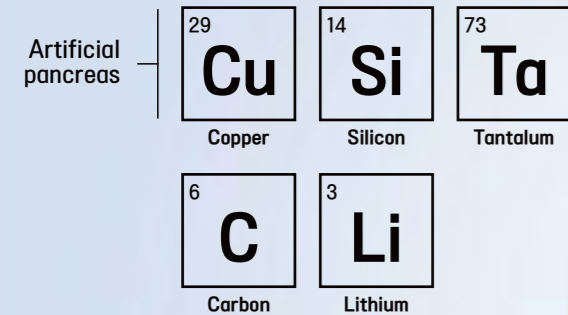
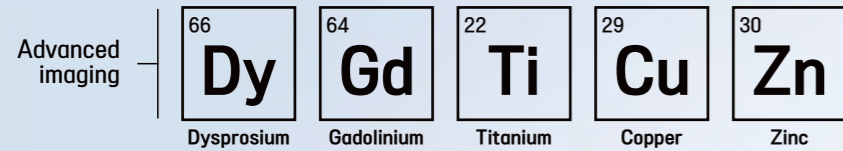

Nuclear medicine diagnoses and treats illnesses such as cancer_

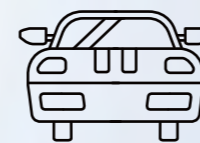
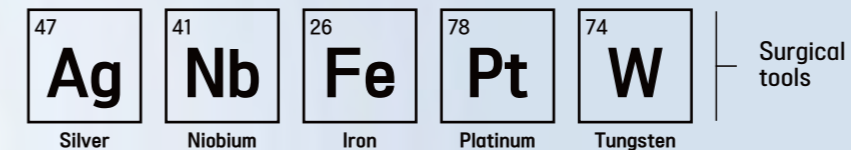
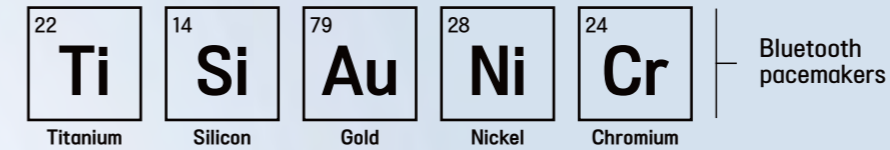
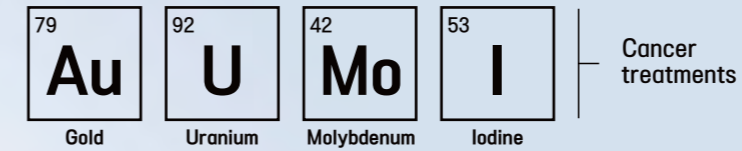
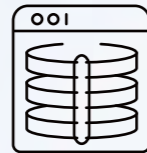

If every person on Earth was a nanometre in size, the planet's population would fit in a Hot Wheels matchbox car_

Australian Academy of Science

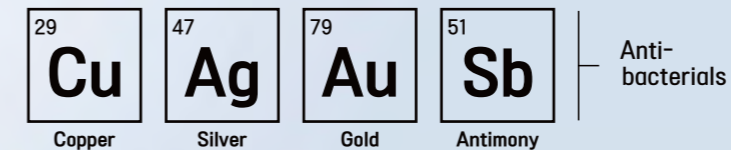

04

Advanced healthcare

Nanoscience, genomics and advanced robotics will revolutionise medical science. Gold nanoparticles are already being engineered to find and treat cancers at the cellular level. Genomic editing will eliminate some diseases, while gene therapy holds the key to curing others, like Alzheimers and Parkinsons. Stem cell advancements promise life-changing treatments for multiple sclerosis and diabetes, while a patient's genetic profile will drive personalised therapies. Telemedicine will also expand healthcare access to millions, and with advancements in robotics, AI, AR and VR, robotic surgery suites controlled remotely by a human surgeon wearing a VR suit might not be too far away.



Floating cities

Boston architect E. Kevin Schopfer conceived a floating city housing 30,000 residents off the coast of Haiti after the 2010 earthquake. Anchored to the ocean floor, 'Harvest City' - a 3.2 km diameter floating complex - was designed to be less susceptible to typhoons and earthquakes.

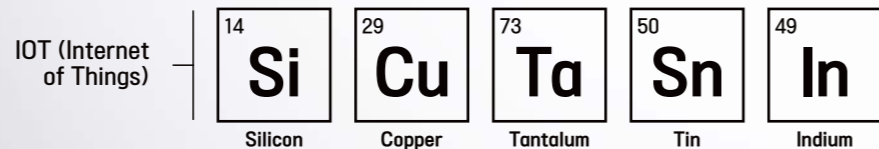
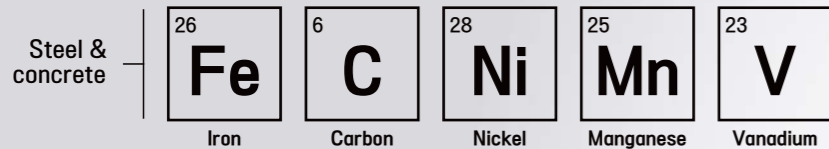
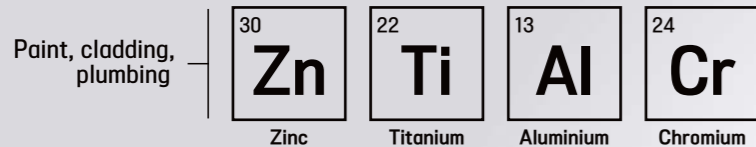

Smart refrigerators with built-in AI could soon be able to monitor product usage, expiry and even reorder items_



Amazon

Smart whitegoods

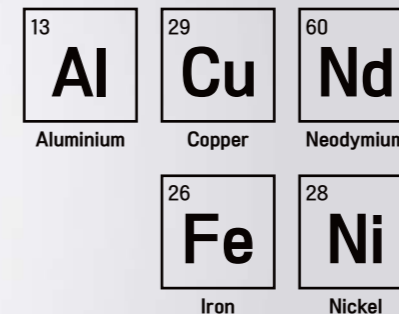

Hydroponics

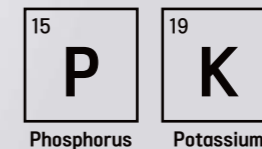

By 2025, IoT-connected devices globally will more than double to 30.9 billion units_

Statista

05

Smart housing

The future of housing is smart, green and interconnected. Voice assistants such as Siri and Alexa are commonplace in homes today, and everything from toothbrushes to refrigerators to light bulbs are connected to the internet. Home entertainment will be more immersive and robots will help with chores. Smart homes will be powered by renewable energy (Tesla has developed solar roof tiles in addition to its batteries); vertical axis wind turbines and heat exchange technology. While aluminium and copper are mainstays, new building materials will also make housing more efficient. Researchers at Washington University in the US have developed a 'smart brick' that utilises red pigment (iron oxide) to store energy like a battery.



Rail speed record

Australia's fastest rail speed record was a middling 210 km/h achieved back in 1999 by Queensland Rail's Electric Tilt Train. An Australian Hyperloop (fancible anytime soon) could see passengers travel between Sydney and Melbourne in 40 minutes, and Sydney and Brisbane in 37 minutes.

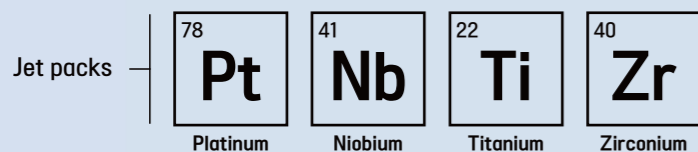
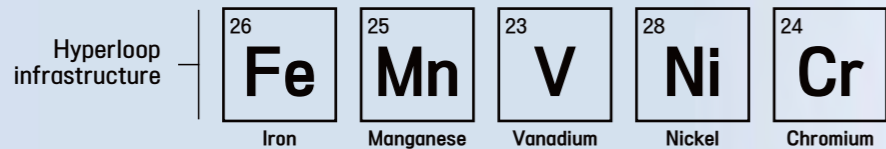
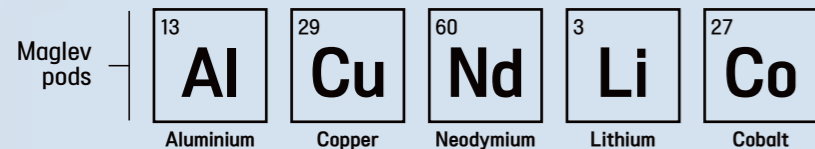

Pods powered by lithium-ion batteries will protect against electricity outages.

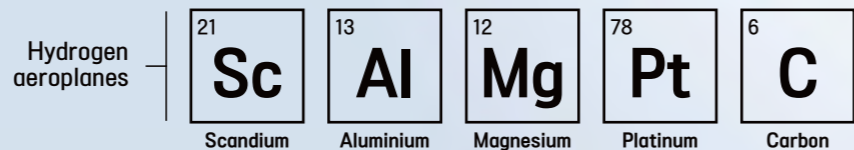
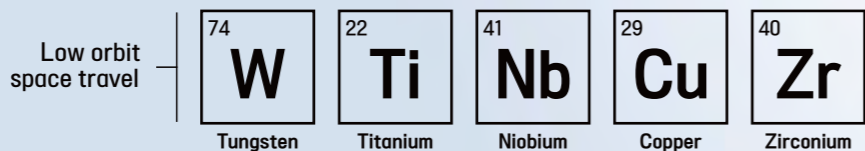
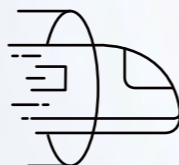

The Virgin Hyperloop could connect cities faster than a Boeing 747.

Virgin Hyperloop

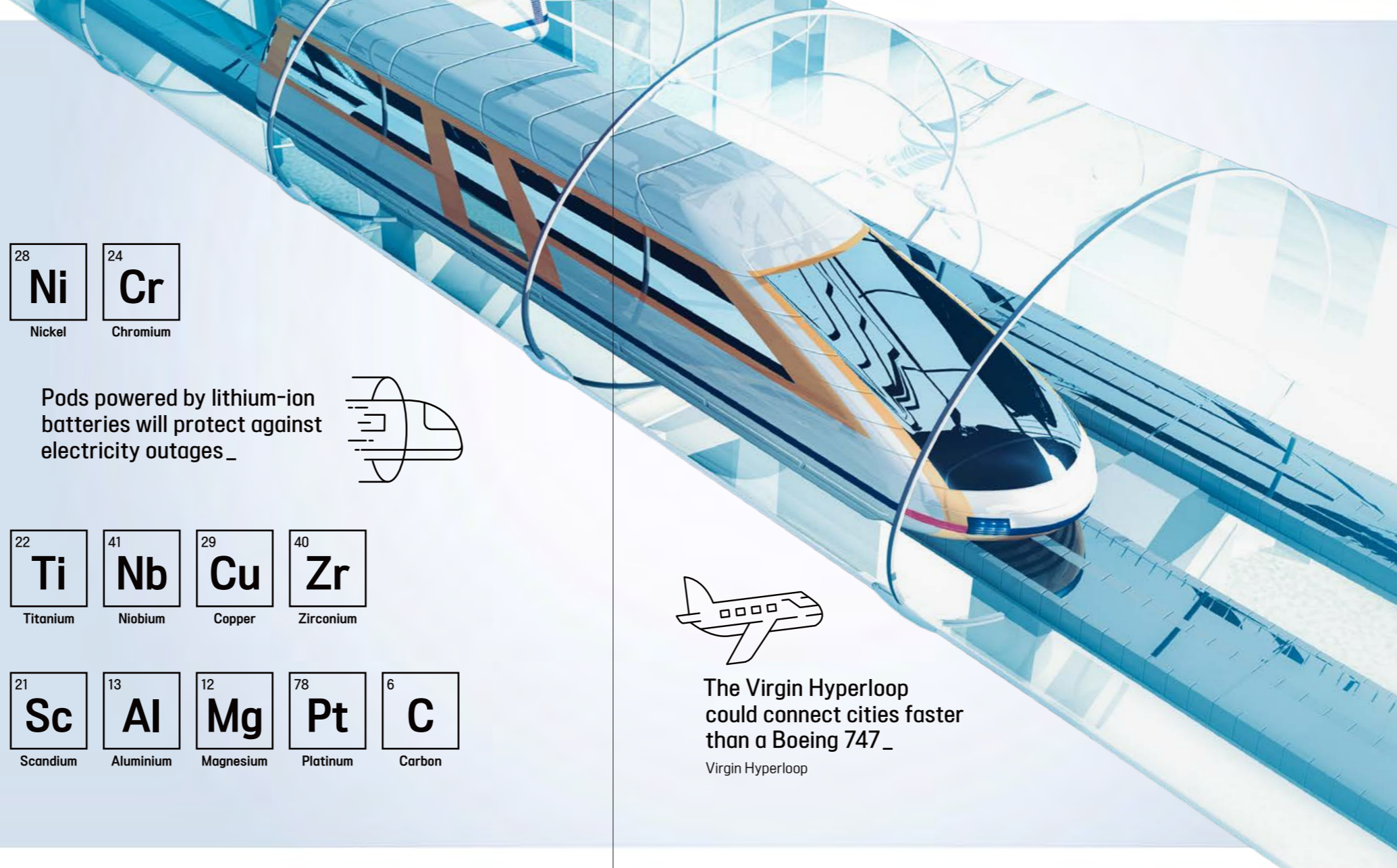

06

Hyper-fast transport

Faster than a speeding bullet train, hyper-fast transport is on the horizon. Tesla founder Elon Musk open sourced his proposal for magnetic levitation (or maglev) pod travel in 2013. Since then, startups from India to the Netherlands have joined the race to develop the technology. The frontrunner is Richard Branson's Virgin Hyperloop, which successfully conducted a passenger trial in November 2020. In simple terms, the Hyperloop is a near-vacuum sealed tube through which magnetic pods are propelled at up to 1200 km/h, just shy of the speed of sound. Fast and immune to weather, a proposed route between New York and Washington DC could reduce travel time from 2 hours and 56 minutes to 29 minutes.

Vertical farm structures

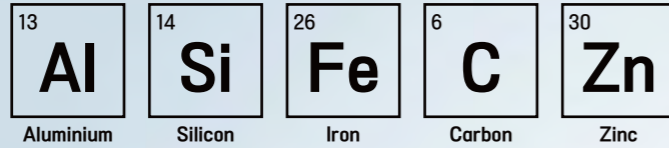

Vertical farm robotics



Vertical farming produces crops using 70-95 per cent less water than normal cultivation.



Lab-made dairy

Japanese scientists unveiled a lab-made Wagyu marbled steak in 2021. Now biotech companies have zeroed in on dairy - milk, cheese, icecream and yoghurt. Instead of meat grown from stem cells, researchers aim to replicate the milk proteins, whey and casein, through a process of fermentation.

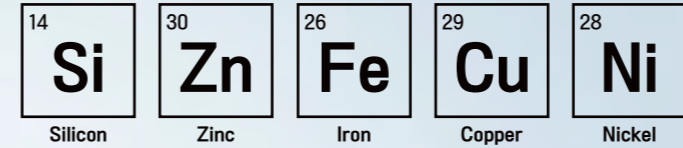

Automated harvesters

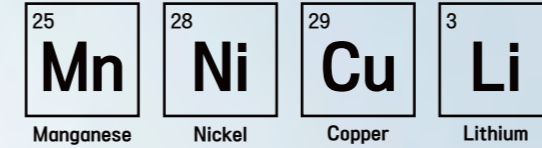

Agricultural drones



Australian supermarkets offer more than 250 plant-based alternative meat products.

Food Frontier



LED lighting



Food laboratories

07

Food production

Climate change and population growth will mean food producers need to do more with less. By 2050, 70 per cent more food will be required to feed the planet's two billion extra people, according to the UN. Machine learning will underpin the technological change required to boost yields, reduce waste and get products to market faster and more efficiently. Plant-based proteins and lab-made meat and dairy will be part of our diets, and with 80 per cent of us living in cities, vertical gardens, rooftop farming and at-home hydroponics will boom. Scientists are forging ahead with 3D-printed food (food-grade syringes replace materials cartridges); and floating farms moored to seabeds and inland lakes could become a reality.



Next level stadium experience

Football fans got a glimpse of the future at the US NFL Super Bowl. Stadium-goers were treated to augmented reality player stats, on-field graphics and comps in 2022. Sponsors are also shifting budgets from flashy commercials towards sharable digital experiences, utilising AR filters and lenses.

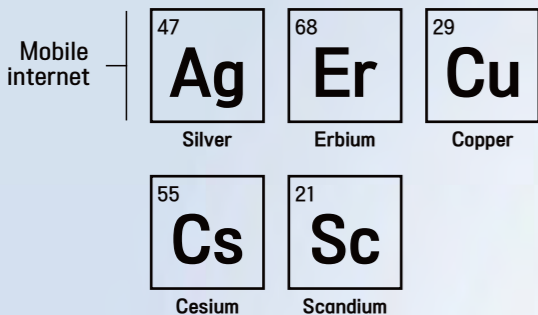

Mobile AR user devices globally will number 1.7 billion by 2024

Statista

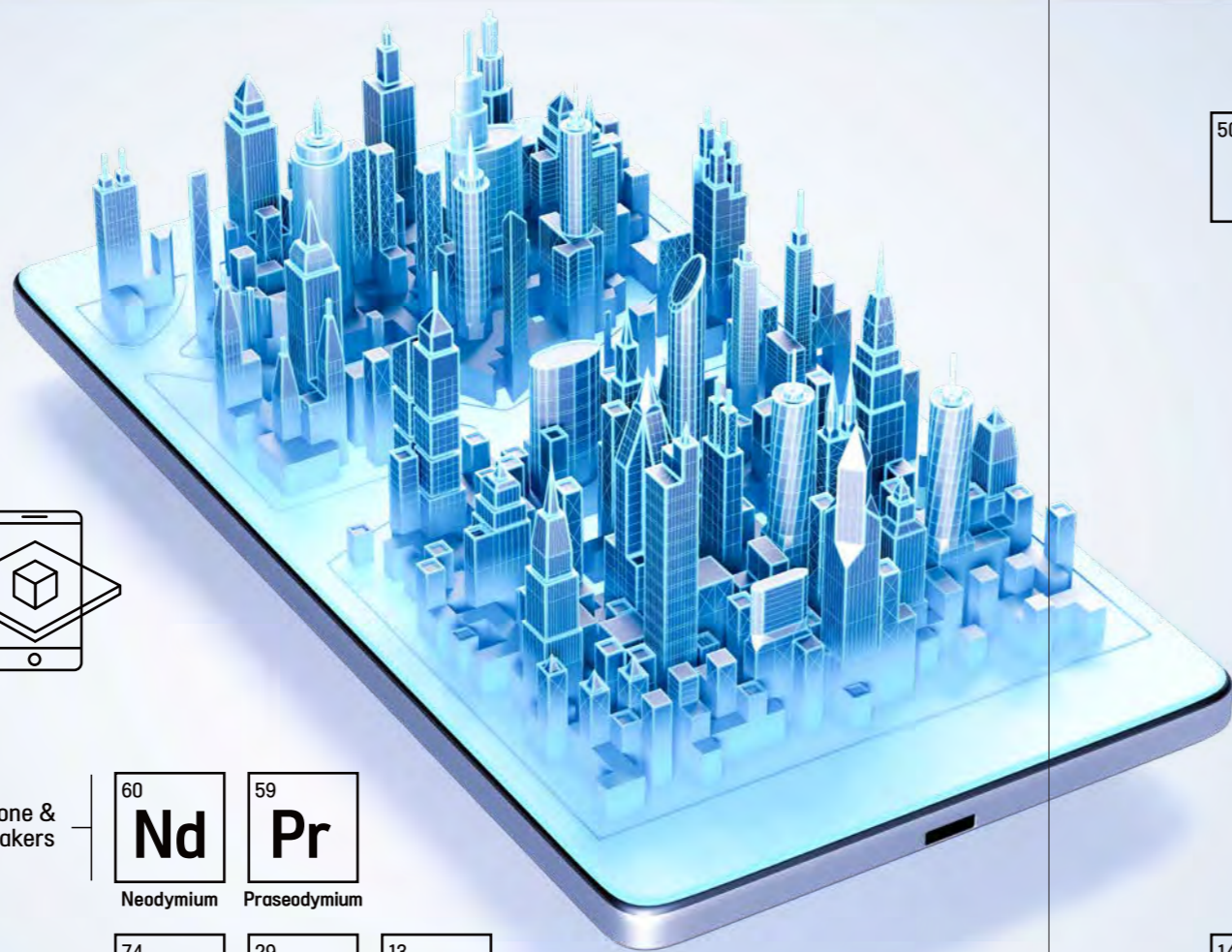

Microphone & speakers

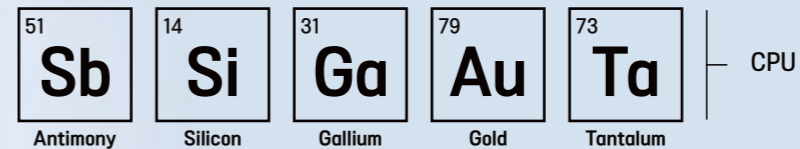
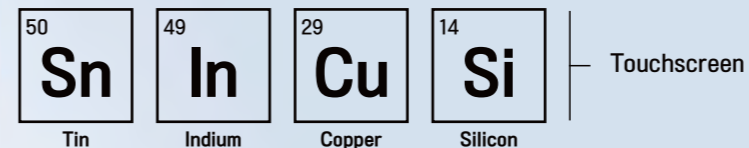
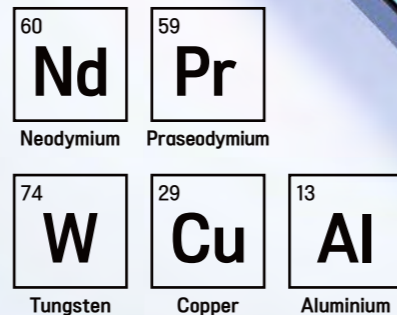

Pokemon GO made \$1.21 billion revenue in 2021, higher than its peak usage in 2016

Sensor Tower

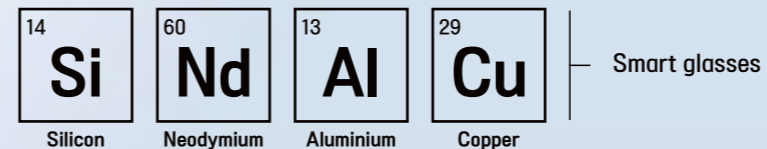
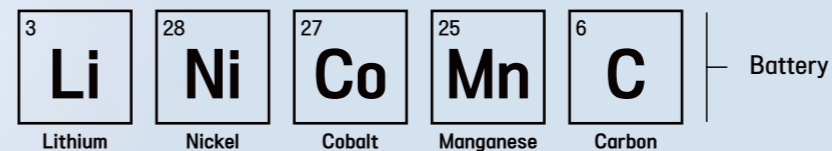

08

AR smart phones

Smartphone makers are scrambling to bring an AR-optimised smartphone to market. While the ultimate destination might be smart glasses and contact lenses that integrate our physical world with a virtual overlay, reimagining the smartphone in our back pocket is the first step. AR has come a long way since Pokemon GO launched in 2016, with real-world application across all industries from retail to real estate. Big things are also predicted for AR in the workplace. Virtual team meetings, screen-free computing and interactive holograms of blueprints and product models could be in our future. The AR market is expected to generate global revenue of \$152 billion by the end of 2030, according to GlobalData.

High-voltage sea cables could enable underwater solar and wind energy exports between nations _

Sun Cable



Solar panels

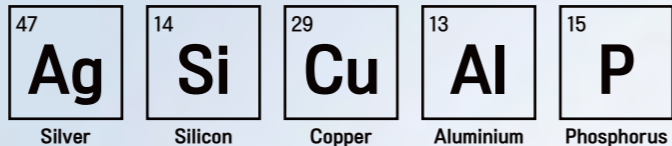

Hydrogen

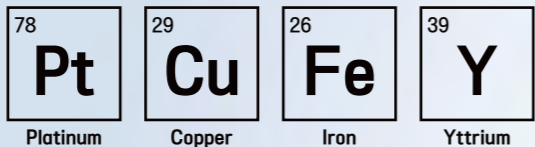

Carbon Capture & Storage

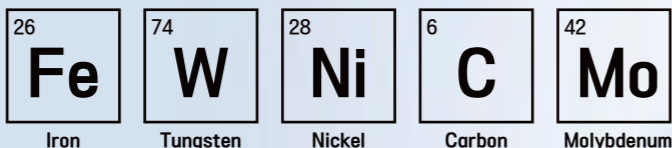

Wind turbines

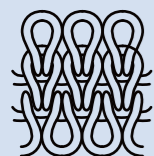

Solar textiles

Forget the nightstand - charging your mobile phone or smartwatch might soon be as simple as slipping into a solar sweater. Nottingham Trent University successfully embedded miniaturised solar cells into yarn that can be knitted into textiles and washed and worn like any other item of clothing.

Smart energy grid

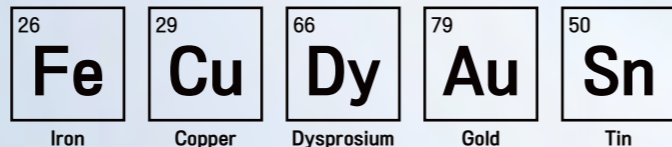

Almost one-third of Australian households have solar panels - the highest take up in the world _

Clean Energy Regulator

Energy storage

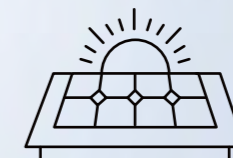

09

Renewable energy

Solar and wind energy generation has come a long way in the last decade. Researchers believe the key to overcoming intermittency and storage challenges is integrating solar, in particular, into our everyday lives. Solar-powered outdoor signage is one successful application; solar roof tiles are another, replacing the need for bulky rooftop panels. Car makers, such as Hyundai and Lexus, have begun installing solar cells on the roofs of EVs and in the near future, glass windows embedded with solar cells could be used to power office buildings, and eventually even our smartphones. Another frontier is solar fabrics - textiles that have micro solar cells integrated into the fibres. Solar thermal fuels are also on the horizon.

Disease immunity could one day be delivered by nanorobots injected into the bloodstream and tasked with preventing viruses _



Antimicrobial materials

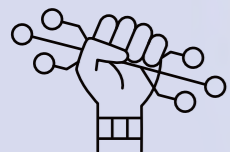
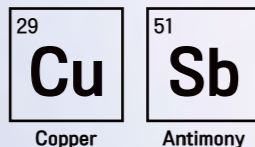
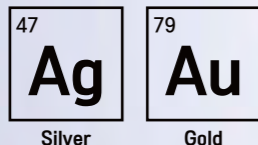

Digital revolution

The COVID-19 pandemic supercharged the digital revolution in Australia. Australian Communications and Media Authority research revealed unprecedented demand for internet services in 2020-21 as work from home became the norm, and education, shopping and health consults moved online.

Laboratory safety systems

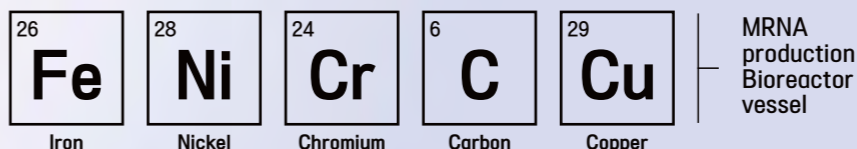
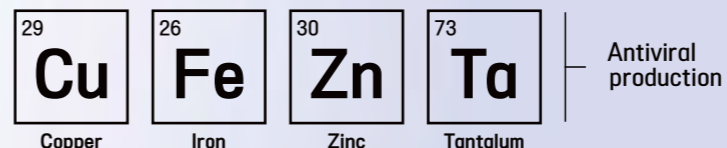
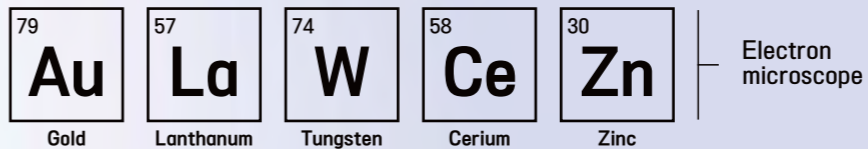
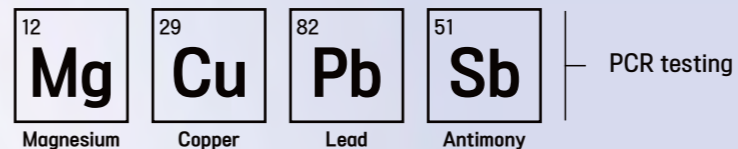
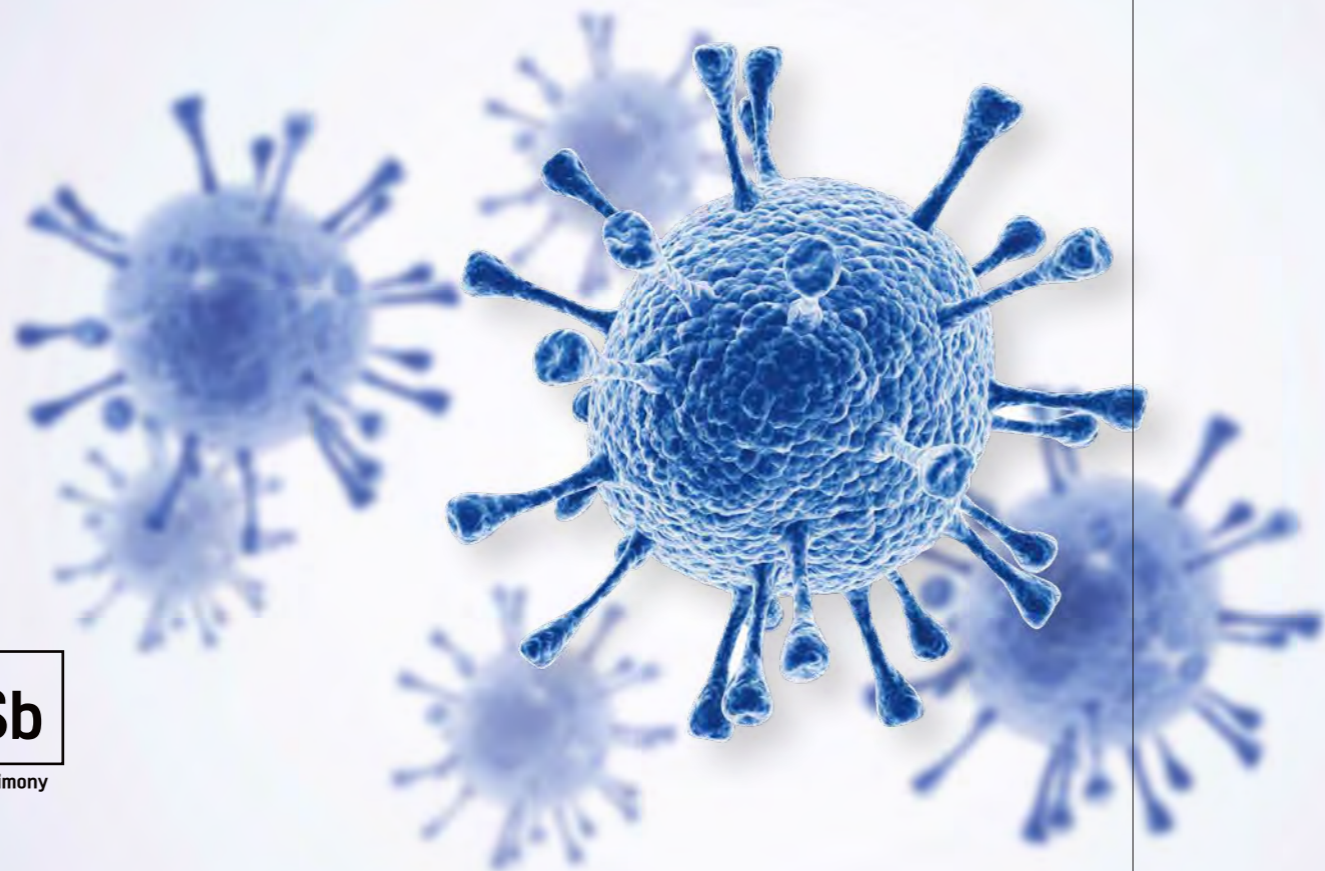
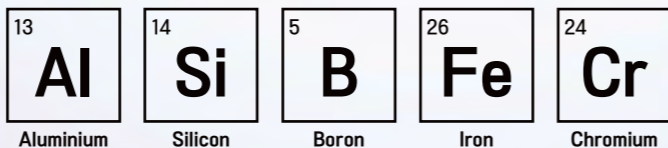

Portable, wearable air purifiers that remove viruses and pathogens from the air you breath could be the next big thing in pandemic PPE _

Air Ring



10

Synthetic virology

COVID-19 turned the world upside down, and scientists warn it won't be the last pandemic we see. The greatest protection against a cataclysmic viral threat in the future is early warning. Advances in genomics and information science, including the advent of gene editing tool CRISPR and AI-enhanced global detection systems, will be critical. It will also require a global commitment to the development and integration of diagnostic tools and data sharing. Shortening vaccine development timelines against future threats is another priority, as is surveillance and reporting of animal supply chains. Science, coupled with advances in technology, is the best weapon humanity has against future pandemics.

Quantum computers require extremely cold temperatures for stability. D-Wave quantum computer cores operate at -273°C _

D-Wave Systems

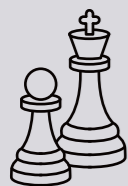
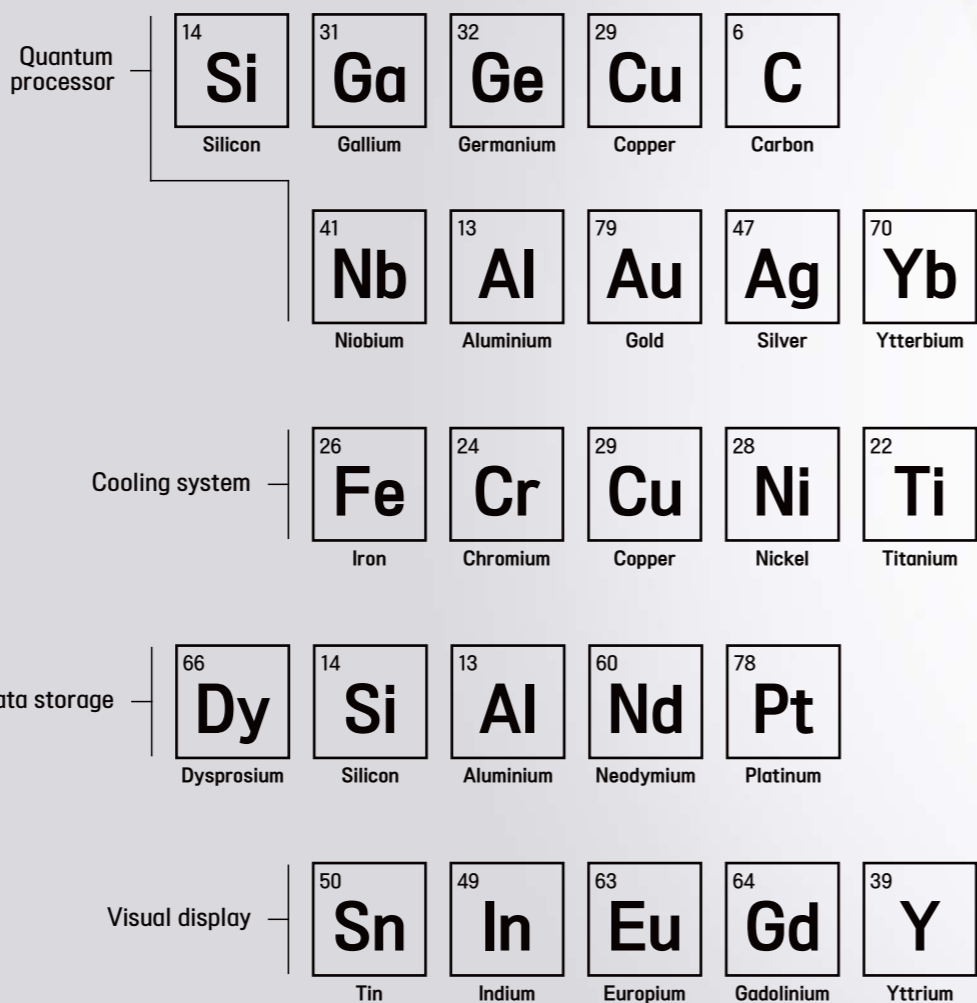
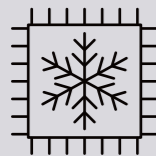

Master moves

World chess champion Garry Kasparov was defeated by IBM's Deep Blue supercomputer in 1997, which demonstrated its ability to examine 200 million possible moves every second. By comparison, a quantum machine would have calculated 1 trillion moves per second, and 4 trillion moves in two seconds.

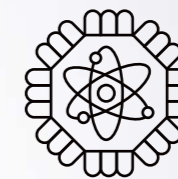
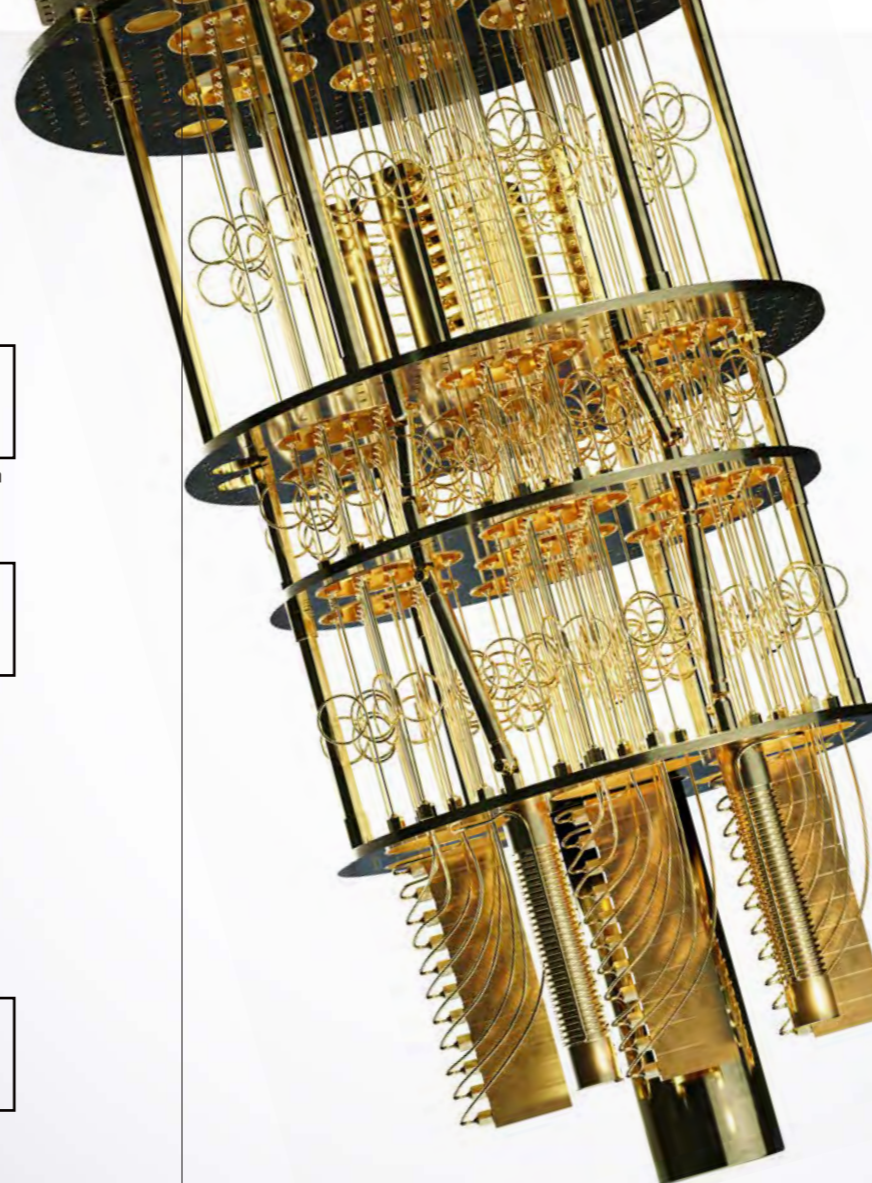

Quantum computing will reshape the material world, from medicine to manufacturing, finance to logistics _

Network connectivity

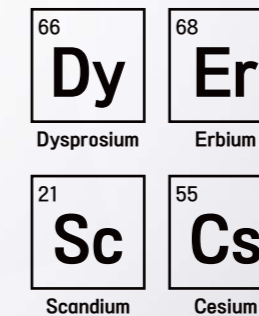

11

Quantum computing

Supercomputers are so last century. Unlike computers today which use binary bits (one and zero) to perform tasks, a quantum computer uses quantum bits, or 'qubits'. Every qubit adds an exponential amount of processing power that makes light work of complex simulations and sub-atomic modelling, promising unimaginable advances in biology, chemistry and material sciences. Big tech companies are leapfrogging each other with advances in the technology. Along with blistering speed, quantum computers use 100 to 1000 times less power than a regular computer. While quantum computers won't help your child plough through their homework, they will redefine the world they grow up in.

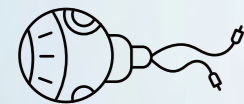

Bionic eye

An Australian-made bionic eye is being fast-tracked for worldwide commercialisation. Developed by Bionic Vision Technologies, the system sends electrical signals from tiny cameras embedded in a pair of glasses to a wearable processor that transmits visual information to an implant behind the retina.

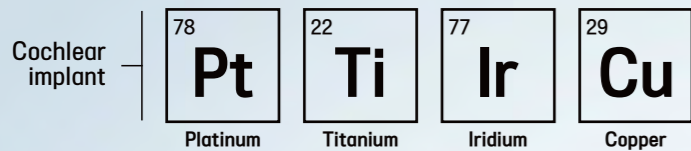
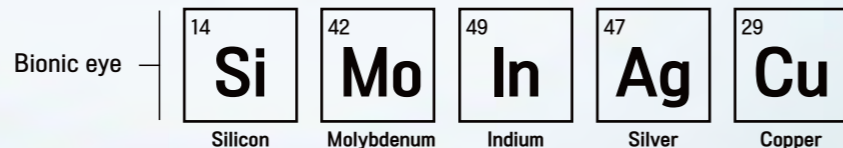

Australian scientist Professor Graeme Clark AC invented the cochlear implant - the first bionic ear - in the 1970s _



Night vision for humans could become a reality after scientists gave the superpower to mice by simply injecting a nanoantenna _

University of Massachusetts

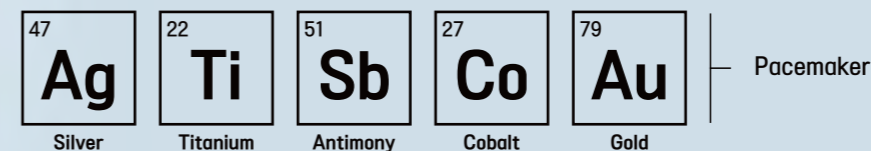
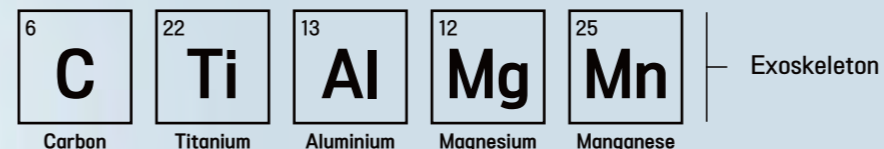
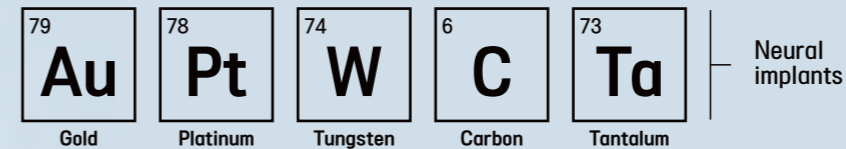
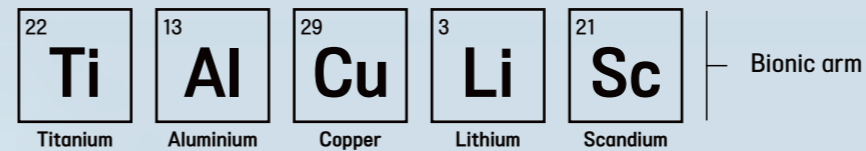

12

Advanced bionics

The rise of robotics and AI has supercharged the world of bionics. Prosthetics fitted with electrodes and sensors can now respond to muscle movement and even stimulate specific nerves to relay pressure and other senses. Advances in neurotechnology are also giving hope to paralysed patients. Doctors in Switzerland implanted nerve boosters in the spines of three paralysed men, enabling them to walk short distances. In 2019, a French man was able to move all four of his paralysed limbs by wearing a mind-controlled exoskeleton suit. Meanwhile, researchers have discovered a self-regeneration gene in some species that could one day see humans - in the far far away future - regrow body parts, just like the salamander or jellyfish!

A sweat-powered smartwatch has been developed that uses as little as 20 microlitres of fluid in place of battery electrolytes _

University of Glasgow

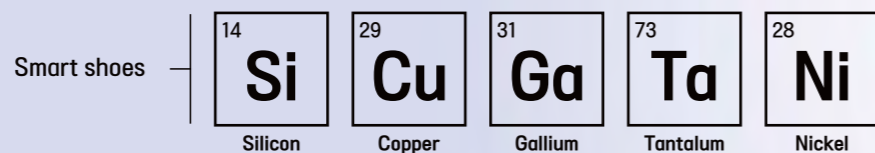
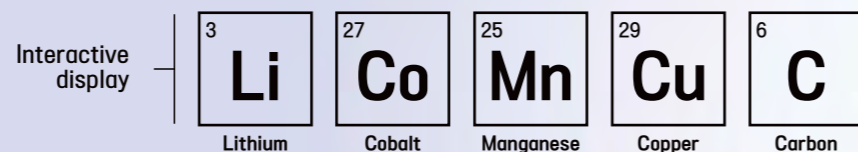
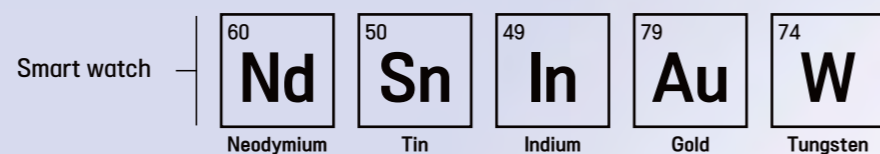

A neural implant is being developed that could one day allow human recipients to access the internet simply by using their mind _

Neuralink

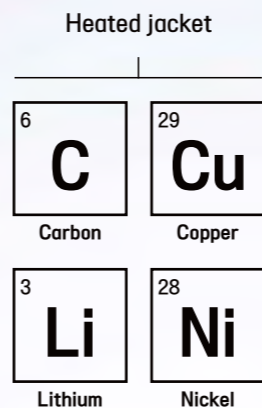
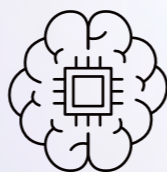

13

Wearable technology

Exercise trackers have been counting our steps and monitoring our heart rates for over a decade. The next wave of wearable tech is advanced textiles - garments with interwoven sensors that relay user data to a smartphone. From footwear (Nike Adapt Shoes) to sleepwear (Under Armour), fashion labels have long dabbled in this space. Ohio State University researchers are also developing 'e-threads' - textiles embedded with antennas and power sources that can transmit data, boost mobile phone reception and perhaps one day even control video games. Wearable health devices, such as glucose monitors and barely there second skin adhesives loaded with sensors, will also become the norm in medicine.



Instant wardrobe

Changing your outfit could soon be as simple as pressing a button. Researchers at the University of Central Florida have developed a color-changing fabric which can be controlled via an app. Threads containing micro-wires and colour-changing pigments are woven into garments.

The James Webb Space Telescope has reached its cosmic base 1.5 million kilometers from Earth. That's four times further away than the Moon _

NASA



James Webb Space Telescope

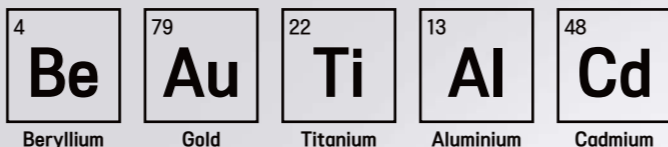

NASA Deep Space Network

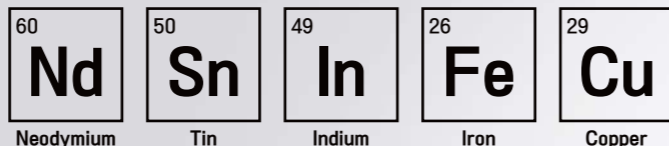

Square Kilometre Array (Radiotelescope network)



Observatory

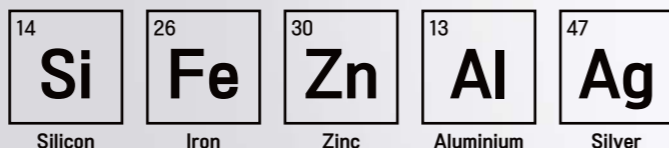

Roman Space Telescope (Launch date: 2027)



The Webb telescope is so sensitive to infrared light it could detect the heat signature of a bumblebee at the distance of the moon _

NASA

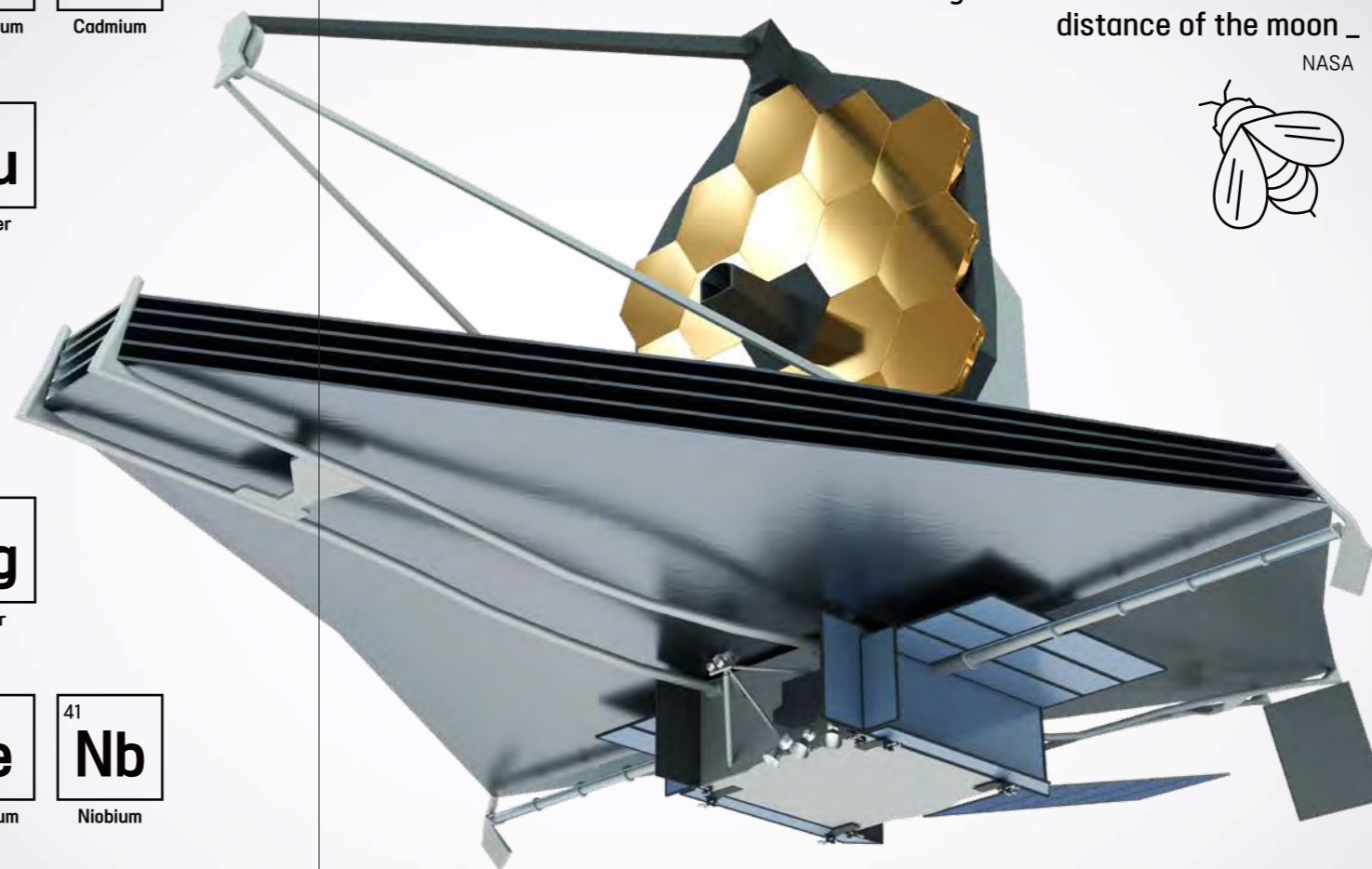

14

Deep space astronomy

Infrared astronomy is another giant leap towards unravelling the mysteries of the universe. NASA's James Webb Space Telescope, launched in December 2021, is a hundred times more powerful than its Hubble predecessor. Powerful mirrors made from beryllium and arranged in 18 gold-plated hexagon segments will enable the infrared telescope to observe the earliest formation of stars and galaxies some 13.5 billion years ago. This peek back in time is made possible because of the time it takes light to travel the vast distances of space. To avoid self-generating radiation, the telescope will be cooled to -223°C by a tennis court-sized sunshield coated with aluminum and doped-silicon to deflect heat.



Modern astronomy

Italian scientist Galileo Galilei (1564-1642) pioneered the use of the telescope in astronomy. Among his discoveries was the moons of Jupiter and the stars of the Milky Way. Unfortunately for Galileo, his work challenged the doctrine of the day and he spent his final years under house arrest.

Japanese scientists are building a space elevator - a 96,000 km tether from the seabed to space made of ultrastrong carbon nanotubes _

Obayashi Corporation

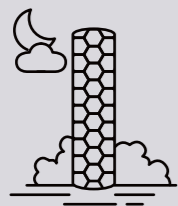

Shuttle	13 Al Aluminium	22 Ti Titanium	29 Cu Copper	21 Sc Scandium	12 Mg Magnesium
Thermal protection	26 Fe Iron	14 Si Silicon	13 Al Aluminium	6 C Carbon	28 Ni Nickel
Rocket engines	41 Nb Niobium	74 W Tungsten	26 Fe Iron	28 Ni Nickel	24 Cr Chromium
Control system	14 Si Silicon	79 Au Gold	73 Ta Tantalum	31 Ga Gallium	66 Dy Dysprosium
Life support	3 Li Lithium	6 C Carbon	29 Cu Copper	47 Ag Silver	95 Am Americium

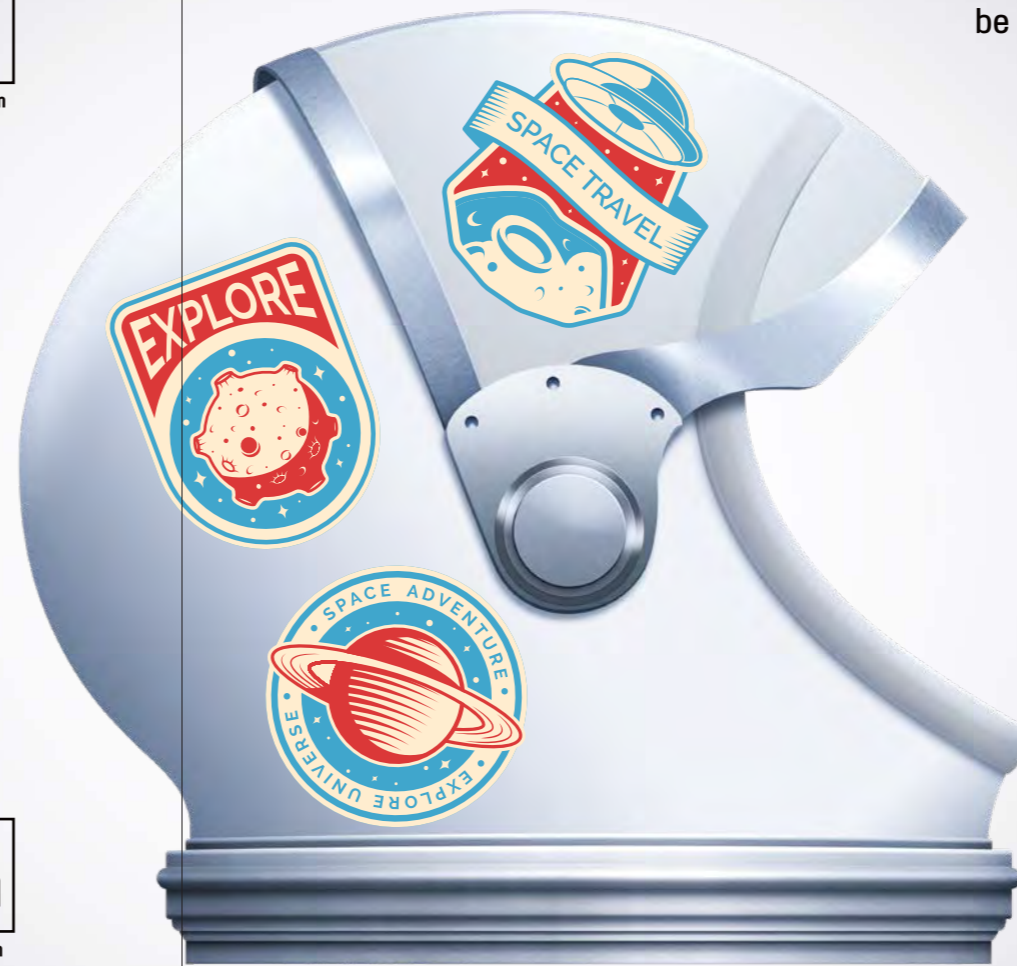

Space tourism could be worth US\$4 billion by the year 2030 _

UBS, 2021

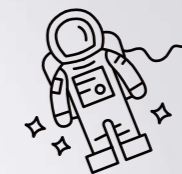

Launch pad

26 Fe Iron	28 Ni Nickel
	30 Zn Zinc



Rapid transit

Intercontinental flights could eventually be superseded by suborbital flights, with passenger spacecraft launching and landing anywhere in the world in less time than it takes to watch an inflight movie. SpaceX, Virgin Galactic and Blue Origin are among the players hoping to reshape air travel.

15

Space tourism

What might once have seemed like science fiction is quickly becoming science fact. Virgin Galactic, SpaceX and Amazon's Blue Origin are on the cusp of offering commercial space travel, albeit at a steep price. Nevertheless, the commercialisation of low earth orbit has bolstered plans for critical infrastructure as space travel becomes more accessible. Reusable rockets, commercial spaceports, even space hotels could be a reality by 2050. Meanwhile, NASA is planning a return trip to the moon in 2025 - more than 50 years after its first lunar landing. Many more multi-nation moon missions are expected to follow (and maybe even to Mars) not only to visit, but to build bases that will allow humans to stay.

Researchers have developed a 3D-printed porous graphene that is lighter than air but as much as 10 times stronger than steel _

Massachusetts Institute of Technology

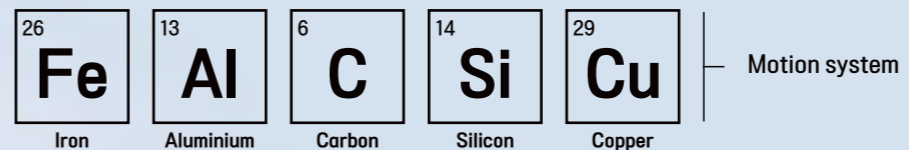
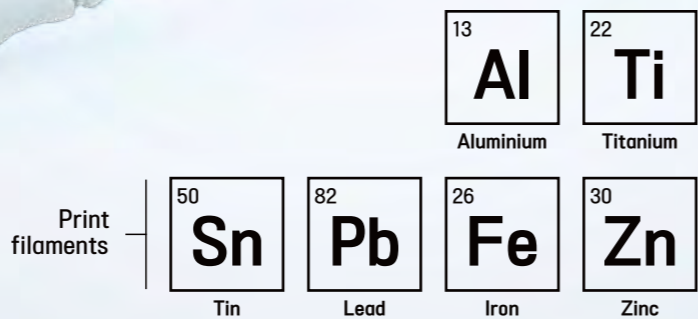
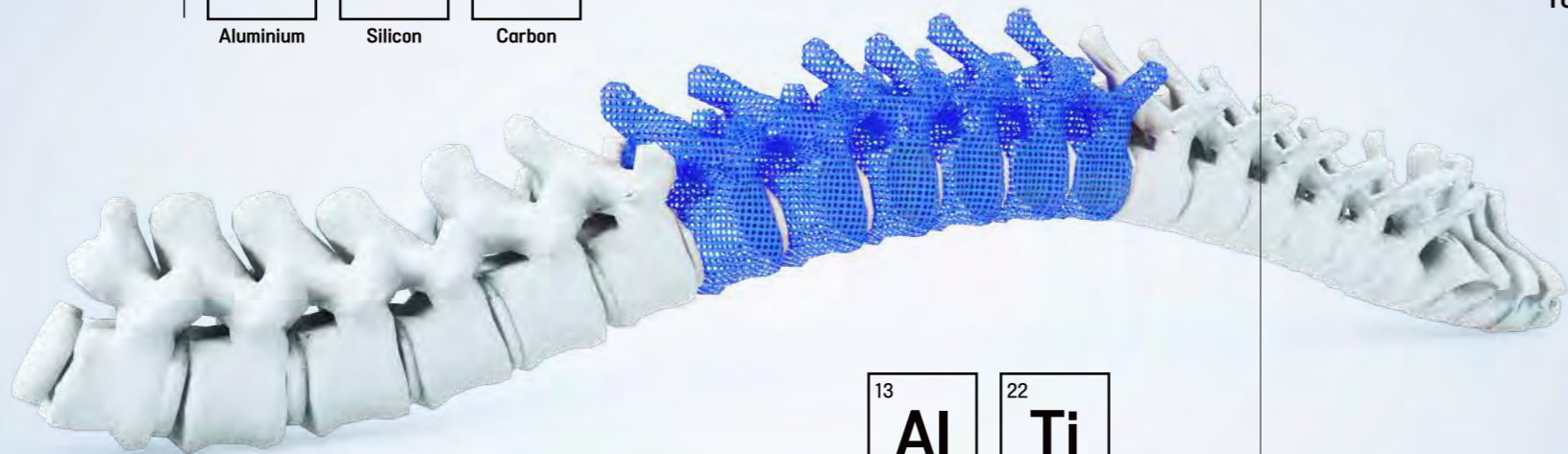
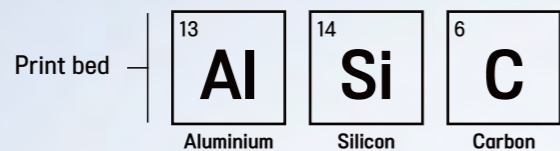
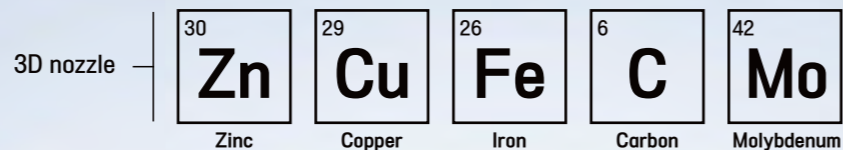
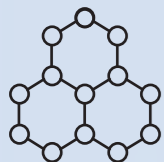

Australian researchers have used 3D printers to create nutritious, safer to swallow meals for people with swallowing disorders _

University of Technology Sydney, Deakin University

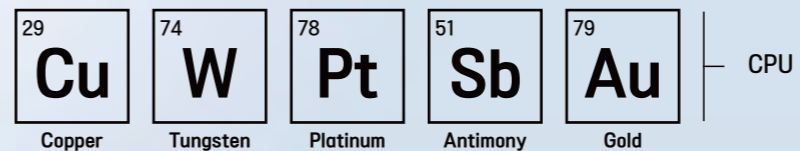
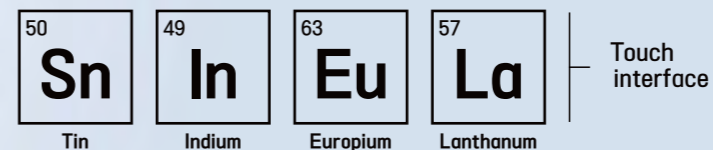
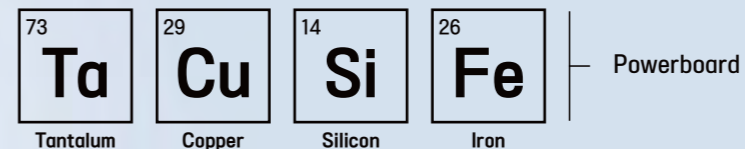

16

3D printing

3D printing will change the way that manufacturers develop, produce and distribute products. Customisable and on-demand, personal fabricators could eventually become as ubiquitous in the home as a microwave. An extension of 3D printing is bioprinting - the artificial creation of human skin, tissue, blood vessels and bones. While the science is some way off, creating a fully transplantable human organ (bioprinting) is already underway in research facilities around the world. In Australia, University of New South Wales researchers have developed a ceramic ink that could eventually be used to print replacement bone inside the human body, as reported in the journal *Advanced Functional Materials*.

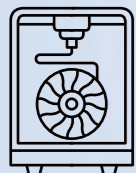

Aerospace

Aerojet Rocketdyne credits its ability to deliver hypersonic flight in large part to 3D printing. The US-based company uses additive manufacturing for rocket engine and defense system applications, and cites costs savings, design flexibility and shorter lead times as some of the benefits.

Mining is critical to decarbonisation. Solar plants, wind farms and EVs are more minerals intensive than hydrocarbon equivalents _

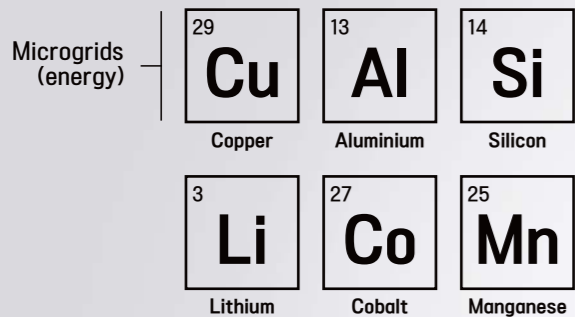

Exploration geophysics

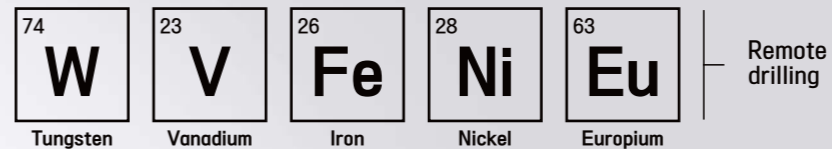
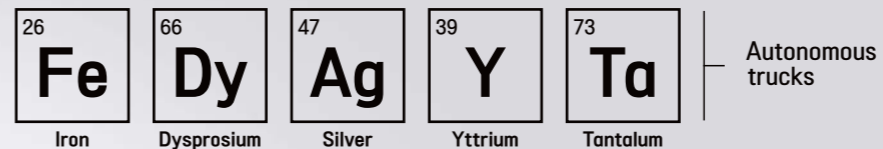
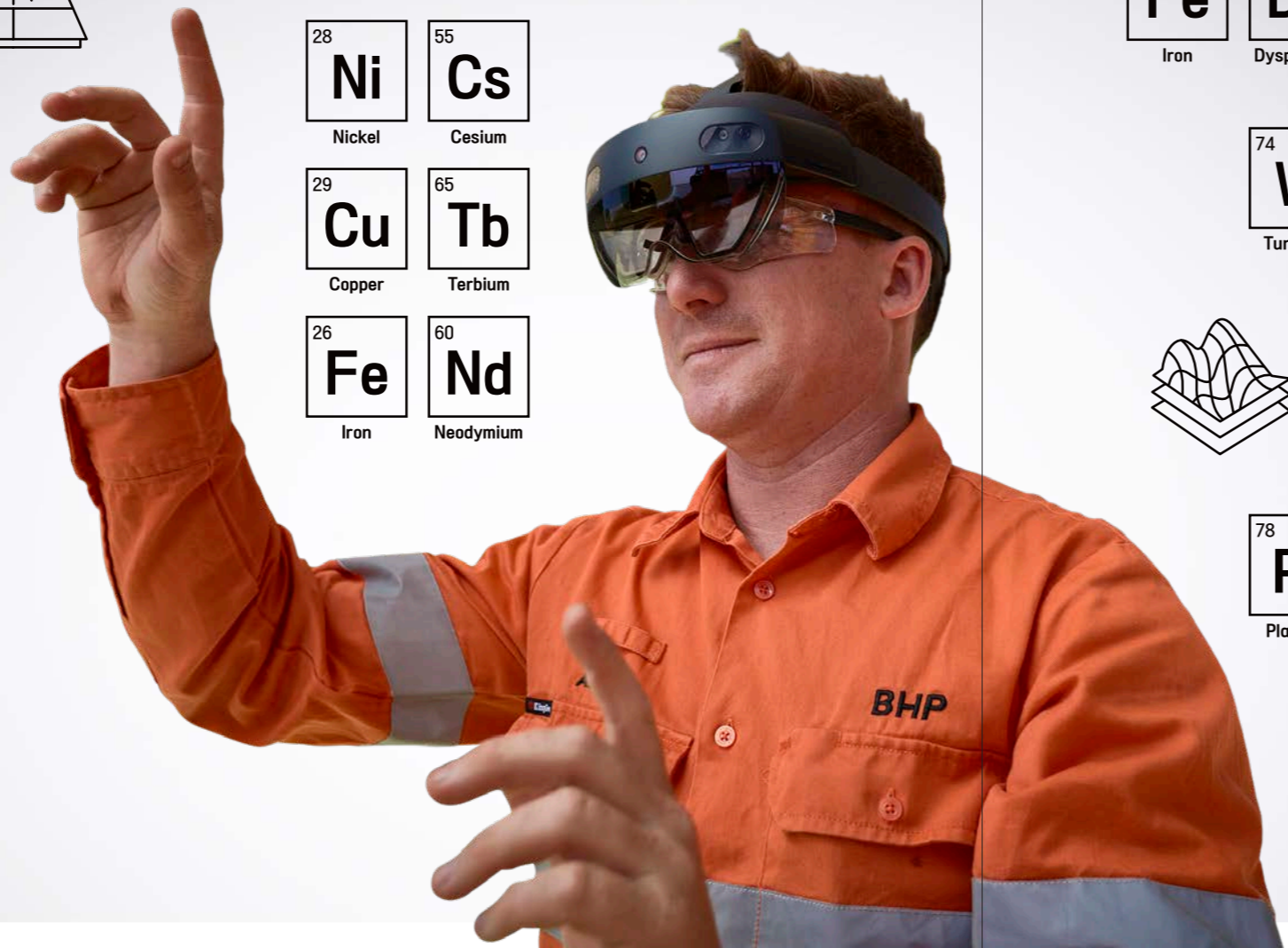
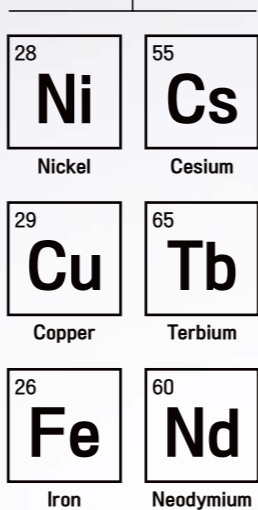

Geoscience Australia's *Exploring for the Future* program is discovering the minerals critical to emerging technologies _

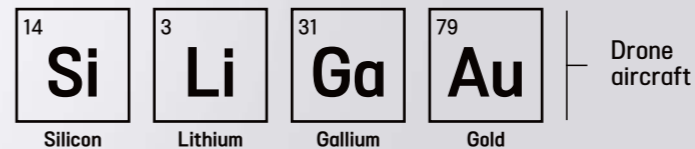

17

Mines of the future

Diverse, digital and decarbonised, Australian mining will become even safer and more sustainable as it contributes the raw metals needed for the global transition to net zero emissions. From robotics to AI, VR to electrification, mine sites of the future (and indeed today) are deploying increasingly advanced technology at an unprecedented rate. Technology is removing people from potentially hazardous situations, predicting and modelling operational improvements and enhancing environmental outcomes. From exploration through to development, operations through to rehabilitation, the technological transformation will secure the future of mining and enable the industry's critical role in global decarbonisation.

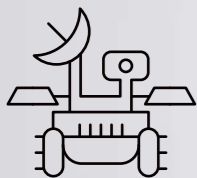

Aussie-made 'Rover'

Nobody knows a lunar-like landscape like Australia's remote miners. Rio Tinto has joined the Australian Remote Operations for Space and Earth consortium - AROSE - to help investigate the feasibility of a locally made lunar rover for possible deployment during NASA's return mission to the Moon.

On Earth, fusion requires temperatures exceeding 100 million degrees Celsius. That's around six times hotter than the Sun's core _

International Atomic Energy Agency



Cryogenic system

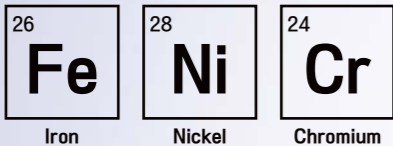

Reactor fuel

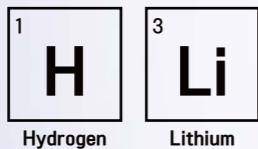

Magnetic force

The world's largest nuclear fusion reactor being built in France is part of a 35-nation collaboration to harness fusion energy. The reactor contains the world's most powerful magnet - 280,000 times stronger than the Earth's magnetic field, and capable of lifting an aircraft carrier out of the water.

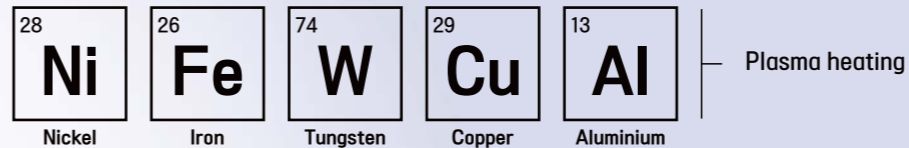
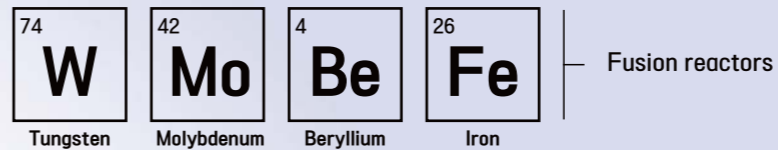
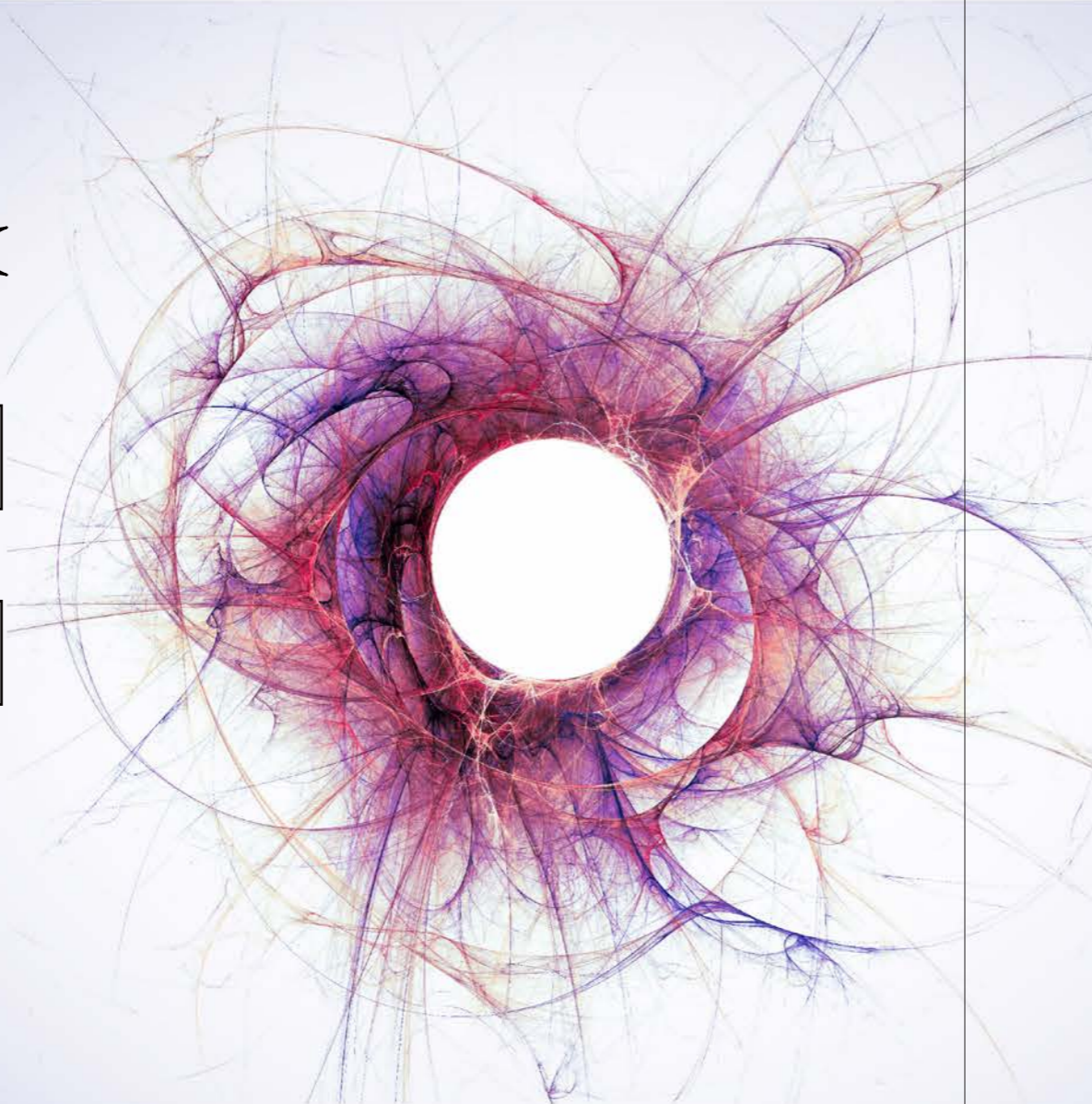

Fusion energy could one day generate a near inexhaustible supply of clean energy for the planet _

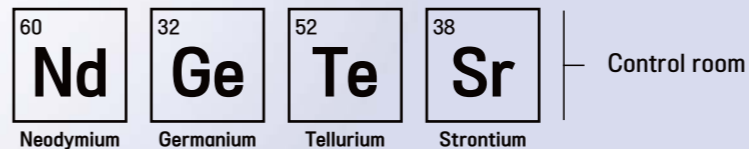
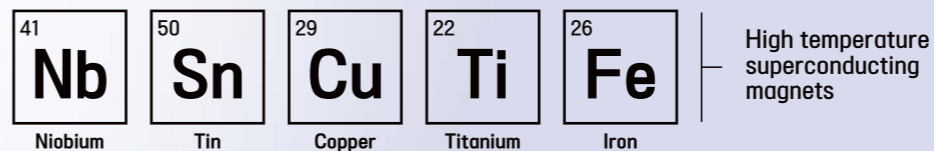

18

Fusion energy

Fusion energy is the game changing technology humankind has been waiting for - climate friendly, low waste energy to power a carbon-free planet. Fusion occurs when two atoms of hydrogen combine at extreme temperatures to form an atom of helium, generating an enormous amount of energy in the process. It is the same process which powers the sun and the stars. The challenge for engineers is creating star power on earth - but they're getting closer. UK researchers created 59 megajoules of fusion over five seconds in early 2022 - enough energy to boil about 60 kettles. That might not sound super impressive, but it was twice as much the previous record breaking output in 1997.



Urban greening has a role in climate mitigation. In Colombia, 30 shaded 'green corridors' have reduced urban temperatures in tropical Medellin by 2°C _

World Economic Forum

Carbon Capture and Storage



Iron Nickel Vanadium

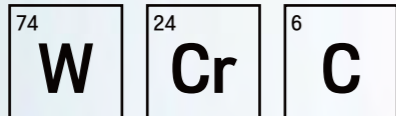

Tungsten Chromium Carbon



Low methane cows

Agriculture is a large contributor of the greenhouse gas methane, and the docile culprit is burping cattle. UK company Zelp has developed a methane-zapping halter for belching bovines that oxidises methane as it is exhaled. The tech tracks methane data for farmers, as well as other herd health metrics.

THE FUTURIST EDITION

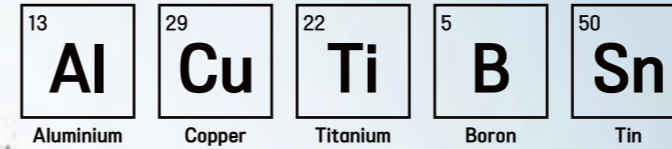

Aluminium Copper Titanium Boron Tin

Direct air capture

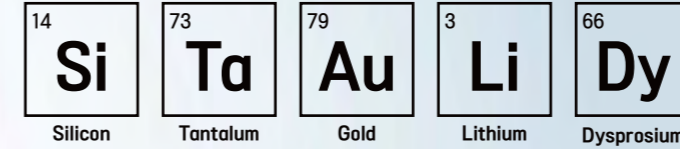

Silicon Tantalum Gold Lithium Dysprosium

Soil carbon sensors

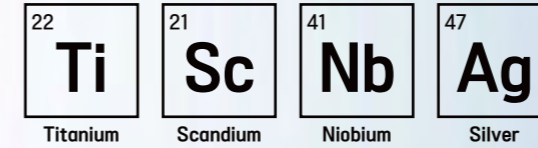

Titanium Scandium Niobium Silver

Satellite observation

Food production and distribution contributes 34 per cent of carbon emissions globally - around 17 times more than commercial aviation _

European Commission Joint Research Centre

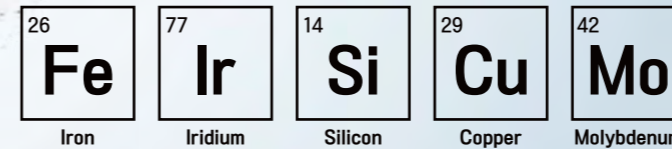

Iron Iridium Silicon Copper Molybdenum

Green steel (Molten oxide electrolysis)

19

Carbon reduction

Atmospheric CO₂ levels have almost doubled since the industrial revolution. While human activity has brought us to this point, human ingenuity might just be our salvation. From digitisation and electrification to green steel and alternative fuels, technological innovation is driving global decarbonisation efforts. Industry is doing much of the heavy lifting with technologies such as carbon capture and storage and direct air capture (ambient air carbon capture for sequestration or the production of carbon neutral fuels). Future technologies will also be critical, such as FuelGems' revolutionary fuel additive that reduces vehicle emissions, or Solidia's lower carbon concrete that cuts production emissions by 70 per cent.

Agriculture is the world's most water intensive industry. A hamburger with cheese and bacon takes around 3140 litres to produce _

United Nations Environment Assembly

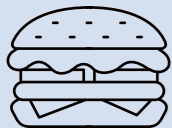

THE FUTURIST EDITION



Cleaner oceans

Tiny hybrid robots made from frog embryonic cells and AI could one day clean the world's oceans of microplastics. Neither traditional robot nor new animal species, Xenobots are a living programmable organism co-developed by Tufts University and the University of Vermont in the US.

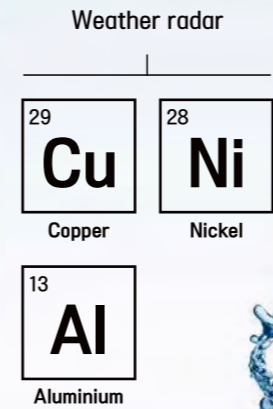
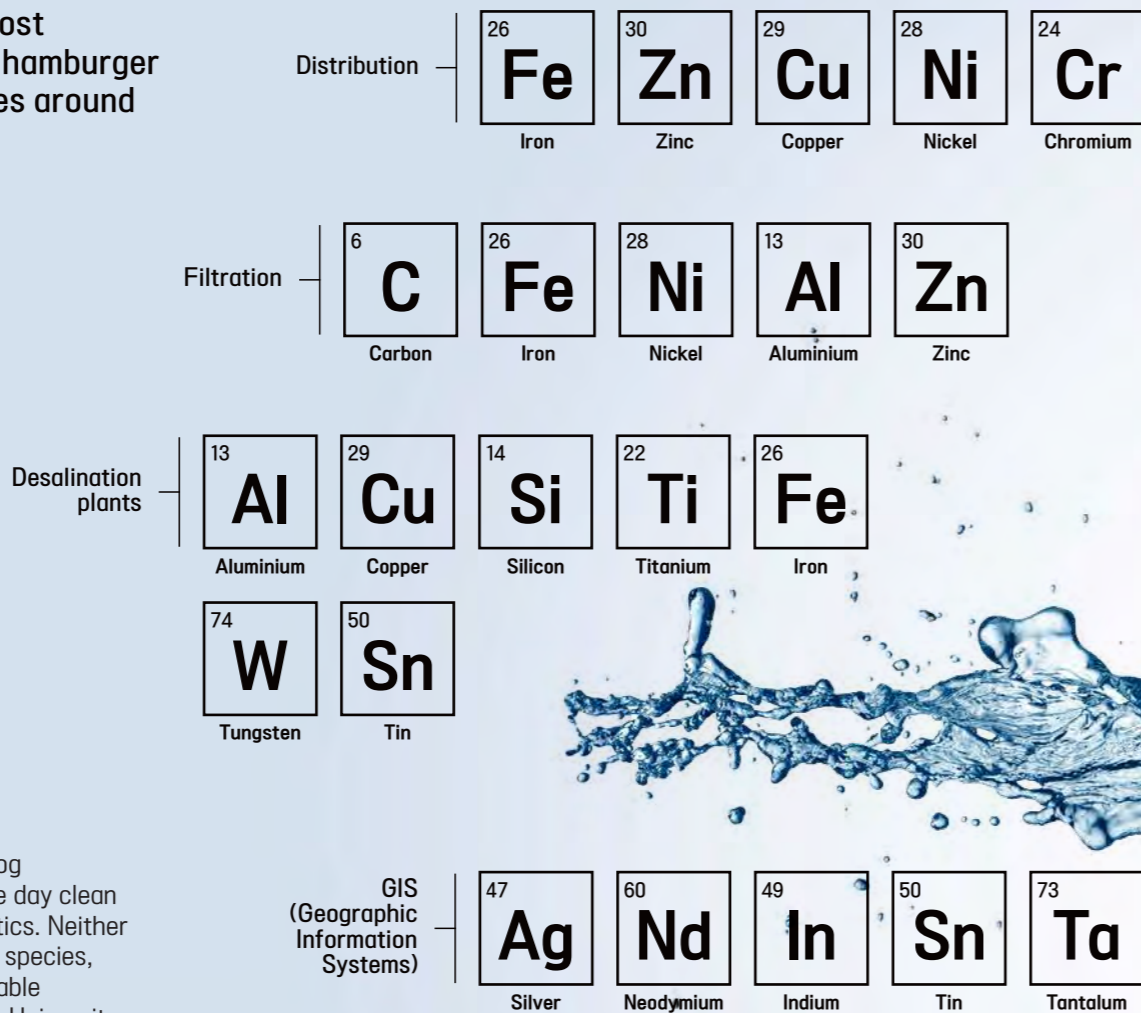

One in four people will be affected by recurring water shortages by 2050 _
United Nations

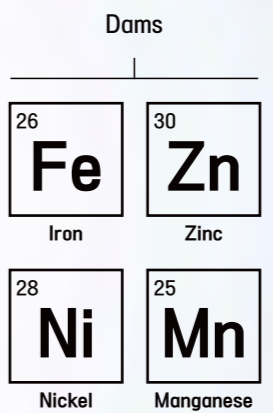
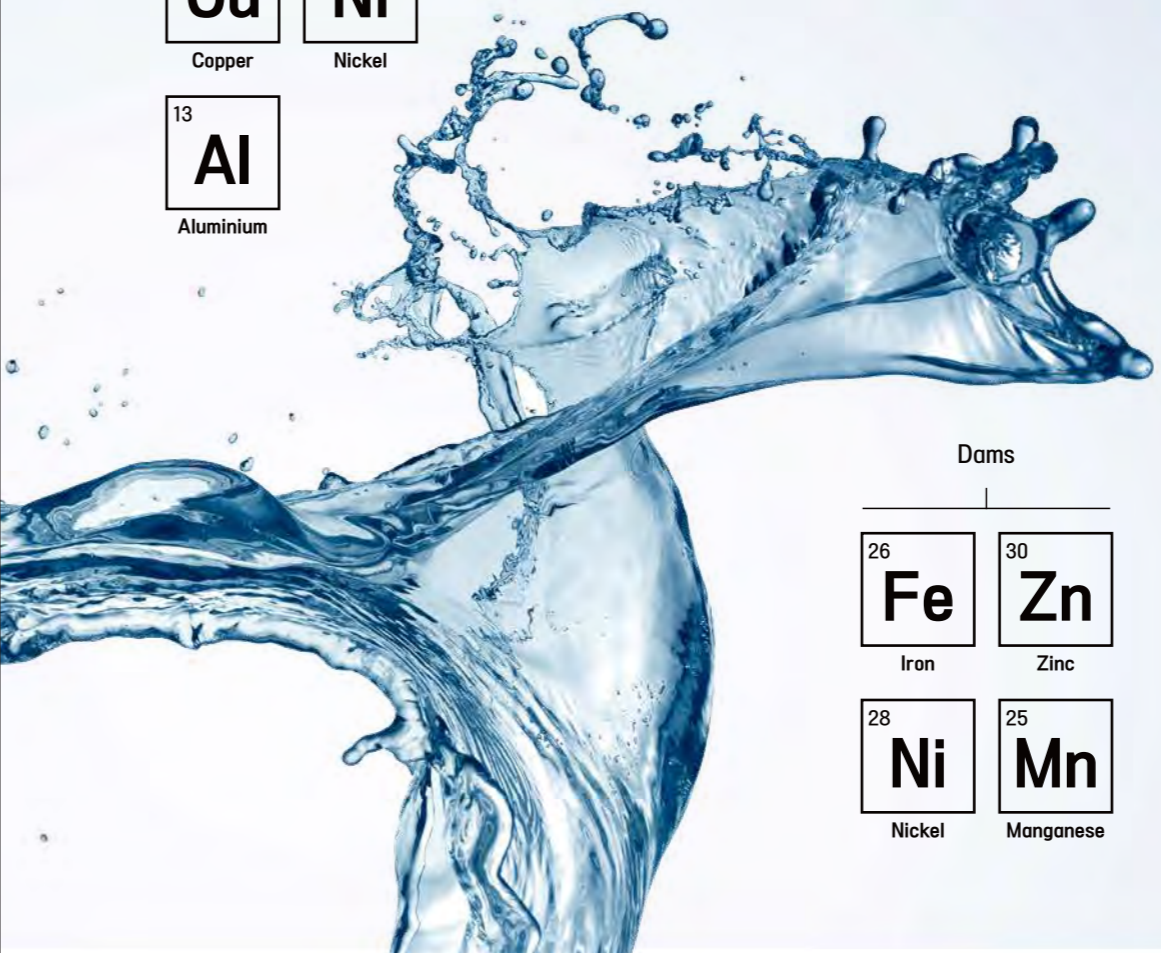

20

Water management

Water scarcity will affect the entire planet by 2040, according to the UN. Hedge funds are already trading 'water futures' like other precious commodities, and competition between nations for water will escalate. While Australia survived its 'Millennium Drought' (1997-2009) by halving business and residential water use and investing in desalination plants, it will take more than that in the future. Global solutions to water scarcity will require the deployment of advanced technologies, from nanotechnology filtration to membrane chemistry to smart monitoring. Improving the energy efficiency of desalination will be critical, as will water treatment innovation and enhanced water re-use and recycling.

Alaskan wood frogs are the living dead of the amphibian world - freezing solid in winter before coming back to life in spring -

National Wildlife Federation



Aussies on ice

Cryopreservation is coming down under with a first-of-its-kind cryonics facility opening near Holbrook in rural NSW. Southern Cryonics will offer whole-body suspensions for around \$150,000 per person, as well as long-term storage, for around 40 deceased people hoping for a second chance at life.

Suspension facility

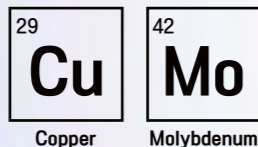

Cryogenic tank (for the dead)

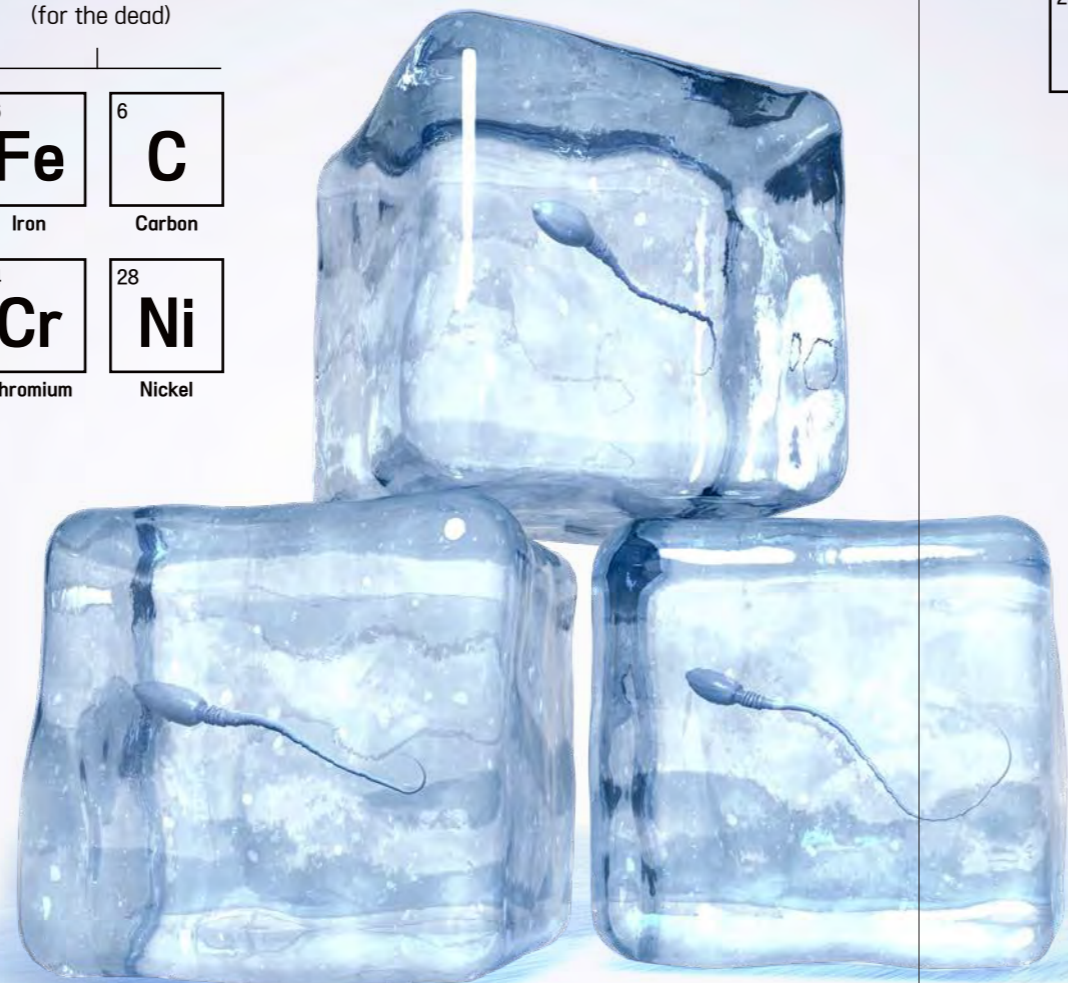
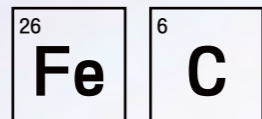

Biomedical monitoring



Almost one in 20 Australian and New Zealand babies were conceived through IVF in 2019 -

UNSW Australia and New Zealand Assisted Reproduction Database

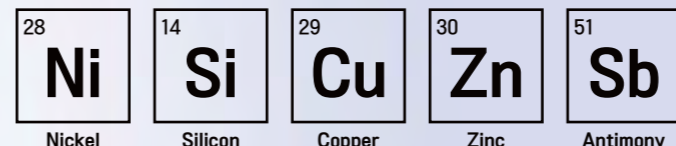

Liquid nitrogen production



IVF storage

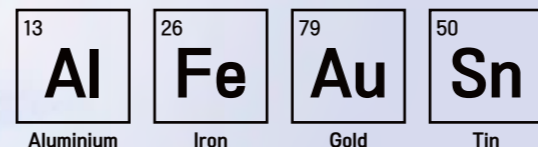

Cryosauna (for the living)

21 Cryonics

While the science might be shaky (and the science community sceptical) that doesn't mean cryonic resurrection won't be possible one day. More than 500 deep-frozen humans in cryonic facilities worldwide have bet their speculative futures on it. Cryo technology - the ultra-low temperature preservation of goods and biomaterials - also has current-day applications that doesn't involve raising the dead. It is widely used in transport, food processing, animal husbandry and pharmaceutical industries, and underpins the success story that is IVF. The challenges facing cryonics might seem insurmountable today, but only time will tell if science can make the necessary strides to realise future reawakenings.

Autonomous air taxis could be transporting spectators between venues during the 2032 Olympic and Paralympic Games in Brisbane _

Wisk Air



Electric propulsion	29 Cu Copper	60 Nd Neodymium	5 B Boron	26 Fe Iron	59 Pr Praseodymium
Super efficient batteries	3 Li Lithium	28 Ni Nickel	27 Co Cobalt	25 Mn Manganese	29 Cu Copper
Aircraft body	13 Al Aluminium	21 Sc Scandium	12 Mg Magnesium	6 C Carbon	22 Ti Titanium
Vision-based sensors	58 Ce Cerium	14 Si Silicon	73 Ta Tantalum	13 Al Aluminium	
Navigation	50 Sn Tin	49 In Indium	47 Ag Silver	29 Cu Copper	74 W Tungsten



Charging station

13 Al Aluminium	26 Fe Iron
29 Cu Copper	6 C Carbon

A New York startup is building a 40-seater eVTOL air bus (a real life Thunderbird 2!) powered by high density lithium batteries _

Kelekona



22

Flying taxis

Fast, efficient and carbon neutral, electric air taxis will revolutionise urban travel. Start ups and established players are feverishly working to develop and certify electric vertical take-off and landing (eVTOL) aircraft, with experts predicting commercial flights as early as 2026. Smaller than a helicopter and built for cross-city transit (automated flights will come later), eVTOLs can travel within a 240 km radius. Flights will take off from vertiports dotted across the city and could be just the answer to beating peak-hour traffic or swapping the city for the coast. Investment in the sector is coming thick and fast. Morgan Stanley predicts the urban air mobility market could be worth more than \$1 trillion by 2040.

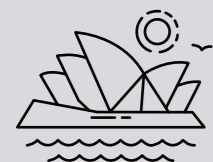

The scenic route

Australian tourism operators have inked deals for 50 eVTOL aircraft from US firm Eve, with progressive deliveries expected from 2026. Queensland's Nautilus Aviation and Sydney Seaplanes will kick off electric air taxi operations domestically with scenic tours, including over the Great Barrier Reef.

Online giant Amazon's market capitalisation is more than the GDP of Australia (\$1.69 trillion to \$1.63 trillion) _

Amazon (US\$, 2021)



Magway (pod propulsion delivery)

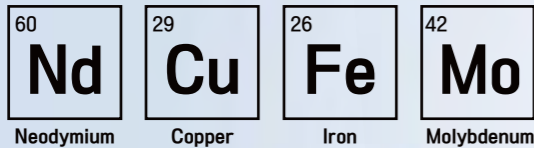

Road network



Communications

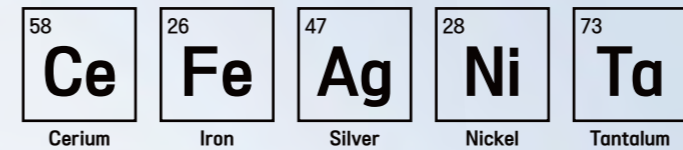
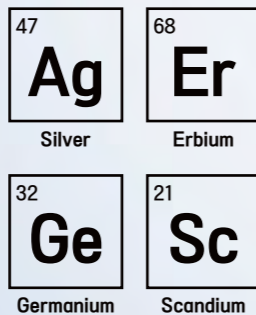

Automated warehouses



Australia is well positioned to supply the critical minerals required to safeguard future supply chains _

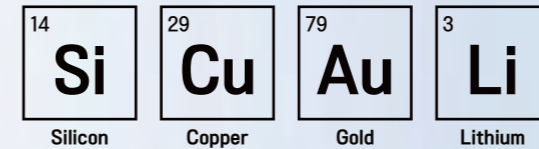

GPS tracking

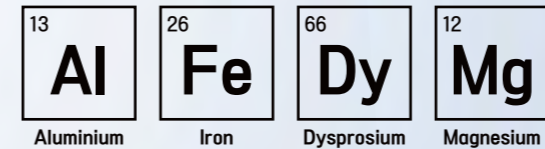

Automated vehicles

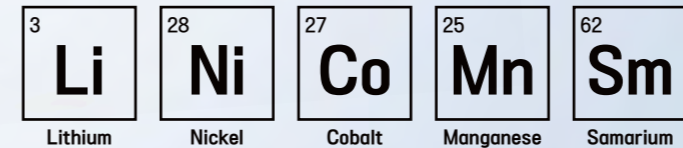

Delivery drones

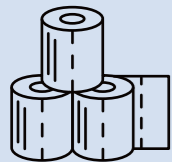

Supply shocks

COVID-19 shone a light on vulnerabilities in global supply chains. Everybody remembers the toilet paper wars of 2020. A far more serious supply issue was the shortage of silicon microchips used in everything from smartphones to electric vehicles. Securing supply chains is a top priority going forward.

23

Supply chain security

Supply chain security will only become more complex in the future. Robotics, automation and advanced analytics will continue to drive digital transformation of the sector, hastened by online shopping, shortened product life cycles and shifting consumer expectations. Mammoth distribution centres and neighbourhood drone deliveries will become more commonplace, and blockchain technology will support new standards in transparency as the ethical sourcing of product materials becomes more important. Demand for sustainably sourced critical minerals for manufacturing, such as lithium, cobalt, copper and nickel, will skyrocket and companies will need an added level of digital dexterity to respond to cybersecurity threats.

A golf ball-sized amount of uranium in a fast reactor provides a lifetime's amount of energy for one person _

Nuclear Energy Institute

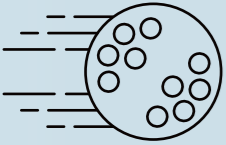

Floating nuclear energy plant

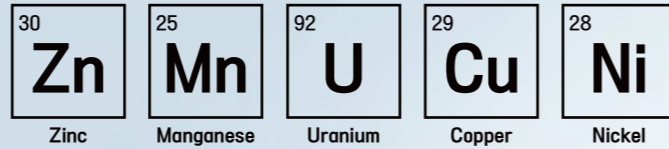

Small Modular Reactors

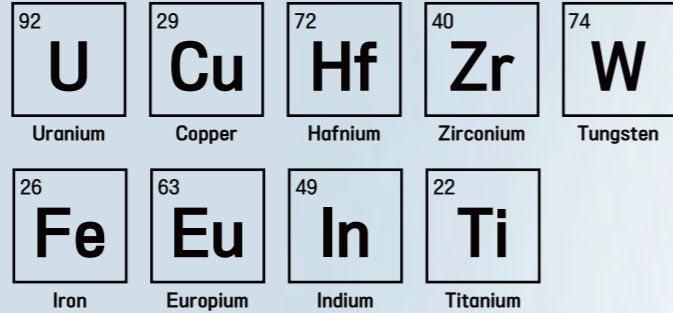

Global electricity produced by Australia's uranium exports is equivalent to 96 per cent of Australia's total electricity needs _

Australian Safeguards and Non-Proliferation Office



Micro nuclear reactor

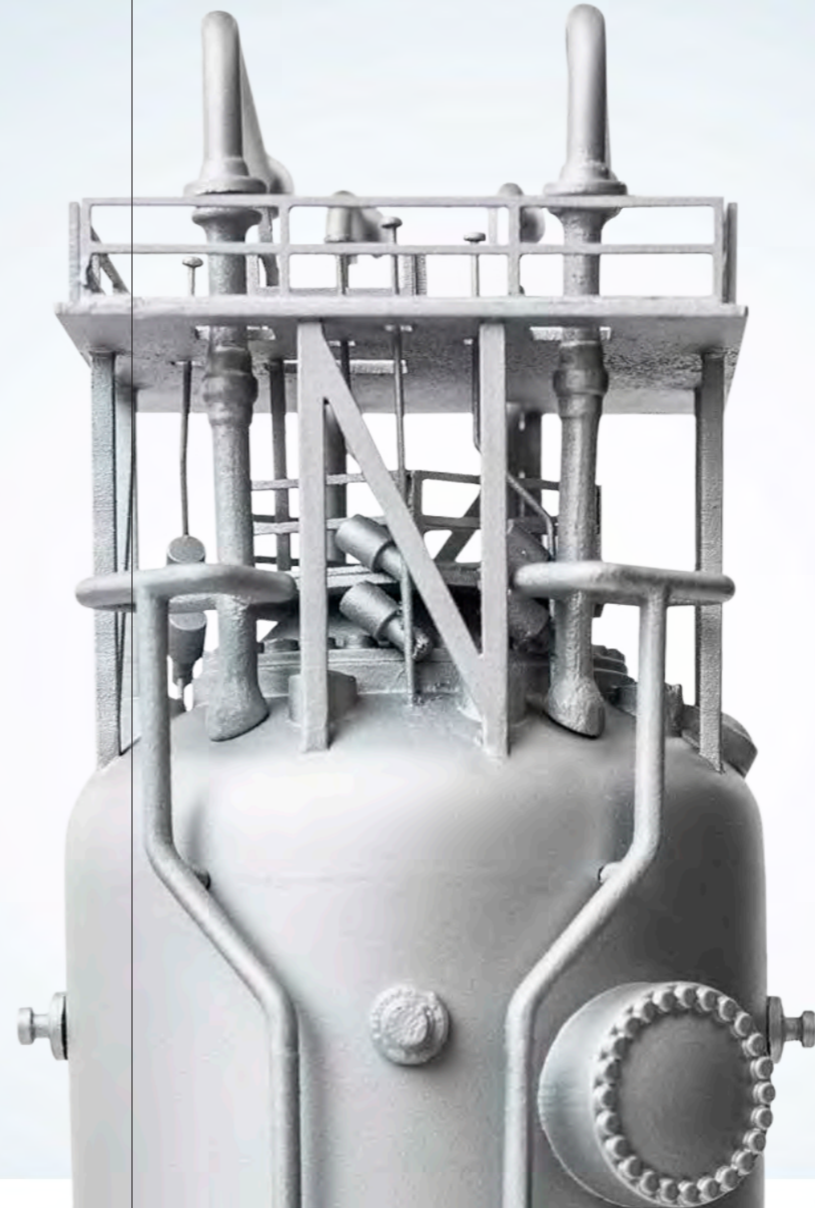
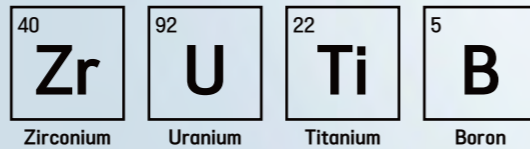

Zero carbon shipping

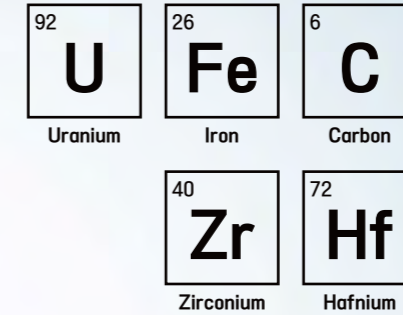

Nuclear medicine

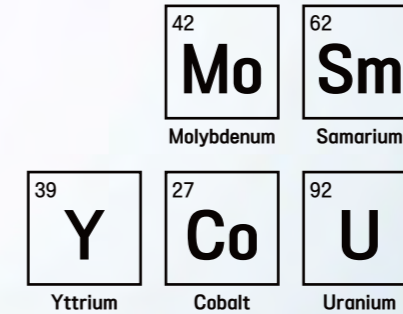

24

Advanced nuclear

Safe, cheap, zero emissions energy is within reach thanks to advanced nuclear technologies. Nuclear energy provides around 10 per cent of the world's electricity, saving the planet more than 2 billion tonnes of CO₂ emissions annually. Beyond electricity generation, emerging reactor designs will process heat, produce hydrogen and desalinate water. Small modular reactors, available later this decade, will provide low cost, reliable energy for millions. Medical research reactors will also be critical, like Australia's OPAL reactor in Lucas Heights. One in two Australians will benefit from life-saving nuclear medicine during their lifetime, according to ANSTO, which produces more than 10,000 nuclear medicine doses weekly.



Nuclear battery

A nuclear waste powered battery that lasts up to 28,000 years might one day power everything from smartphones to electric vehicles to spacecraft. The Nano Diamond Battery, developed by US startup NDB, uses layers of synthetic diamonds to protect the battery's radioactive core.

Bitcoin mining consumes more energy than Norway, and 10 times more energy than Google, Meta and Microsoft combined _

Cambridge Centre for Alternative Finance

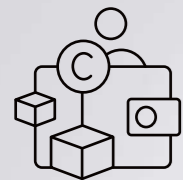

Precious metals

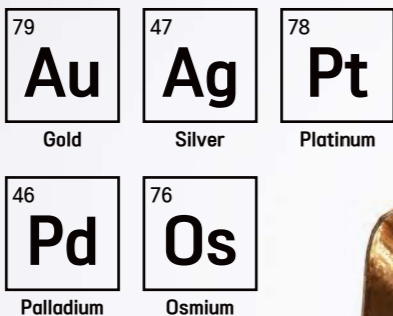

Share trading platforms

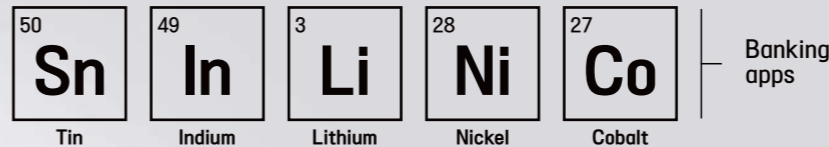
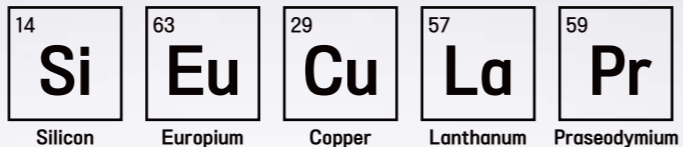

Banking apps

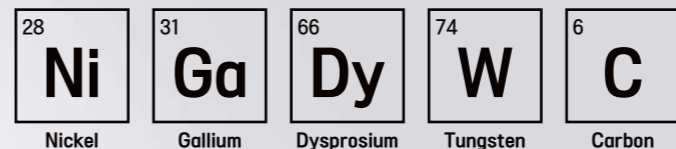

Digital wallet

NFT sales - the digital ownership of unique assets such as audio clips and images - topped \$17.6 billion in 2021, a 200-fold year-on-year increase _

NFT Market Report, Non-Fungible.com

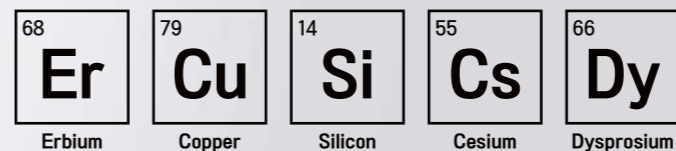

Digital payment systems

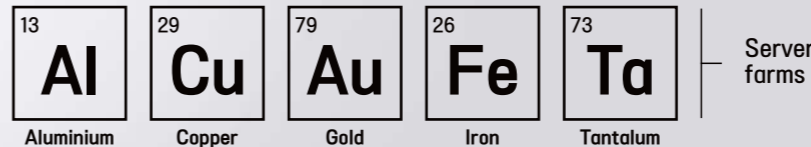

Server farms

25

Digital economy

E-commerce and digital banking heralded the biggest disruption to financial systems in decades. While the days of physical cash might be numbered, the burgeoning digital economy, backed by faster internet speeds and enhanced internet security, is still in its infancy. Cryptocurrencies, blockchain and the mainstreaming of non-fungible tokens (NFTs) has captured the imaginations of everybody from tech billionaires to mum and dad investors. But it takes a brave soul to ride the volatile crypto waves - the market lost \$2 trillion in the first half of 2022, and more than 40 countries have banned or restricted the use of cryptos. The only safe bet, it seems, is on the OG of strategic assets - gold - the safest haven of all in complex times.



Digital gold

Gold-backed digital tokens have emerged as a new wealth asset. Perth Mint issued the world's first gold digital token on a public blockchain - the Perth Mint Gold Token - in 2020. Backed by government guaranteed gold stored at The Perth Mint, digital tokens are traded through the Mint's GoldPass app.

The world's first zero emissions hydrogen-powered passenger aircraft could be in service by 2035 _

Airbus



Hydrogen aircraft

78 Pt Platinum	60 Nd Neodymium	13 Al Aluminium
-----------------------------	------------------------------	------------------------------

Hydrogen trucks

29 Cu Copper	26 Fe Iron	78 Pt Platinum	13 Si Silicon	74 W Tungsten
---------------------------	-------------------------	-----------------------------	----------------------------	----------------------------

Hydrogen storage

26 Fe Iron	13 Al Aluminium
6 C Carbon	24 Cr Chromium



Hydrogen superpower

Australia is positioning itself as a hydrogen superpower. The Federal Government is investing \$1.4 billion to establish a hydrogen industry, with the aim of becoming a major global player by 2030. Hydrogen production for export and domestic use could be worth more than \$50 billion to Australia in 2050.

Refuelling stations

30 Zn Zinc	13 Si Silicon	29 Cu Copper	13 Al Aluminium	26 Fe Iron
-------------------------	----------------------------	---------------------------	------------------------------	-------------------------

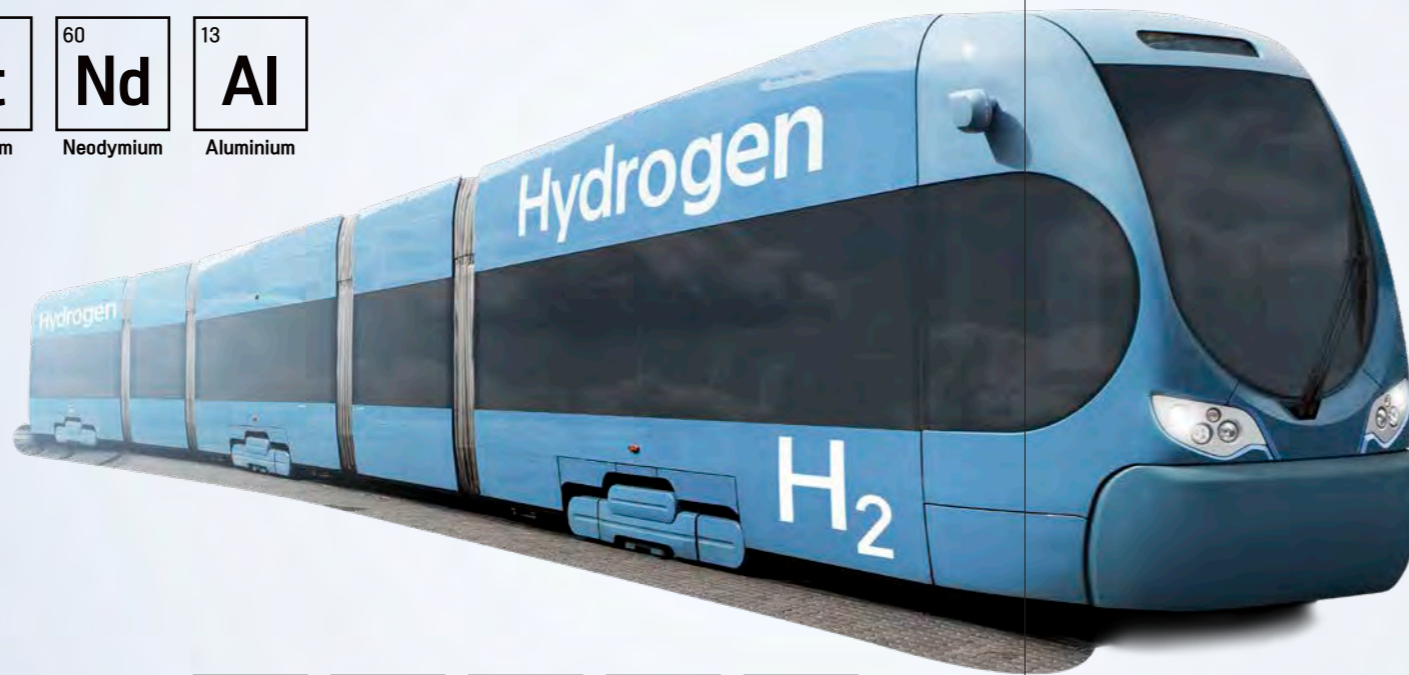

The only emissions from a hydrogen-powered vehicle is water clean enough to drink (although best you don't) _



78 Pt Platinum	77 Ir Iridium
-----------------------------	----------------------------

Electrolyser (Hydrogen production)

27 Co Cobalt	28 Ni Nickel	25 Mn Manganese
---------------------------	---------------------------	------------------------------

26 Fe Iron	13 Al Aluminium	28 Ni Nickel
-------------------------	------------------------------	---------------------------

Hydrogen steel (Green steel)

30 Zn Zinc	29 Cu Copper
-------------------------	---------------------------

26

Hydrogen energy

Hydrogen is the wunderkind of future fuels, carrying the decarbonisation ambitions of the transportation and freight sectors, as well as energy-intensive industries, such as steel and cement production. The future of hydrogen production is electrolysis - the passage of an electrical current through water - which makes for an emissions-free energy source when electricity from wind, solar and nuclear is used. According to Wood Mackenzie, global demand for low-carbon hydrogen could rise six-fold by mid-century, while Deloitte estimates the market could be worth US\$2 trillion. With energy demand set to climb almost 50 per cent by 2050, it seems a safe bet hydrogen will play a much larger role in the future energy mix.

Australia's Synchrotron produces a light beam a million times brighter than the sun to help unlock the sub-atomic secrets of materials _

ANSTO



Australian Synchrotron	79 Au Gold	74 W Tungsten	60 Nd Neodymium	72 Hf Hafnium	28 Ni Nickel	78 Pt Platinum
------------------------	-------------------------	----------------------------	------------------------------	----------------------------	---------------------------	-----------------------------

Dark matter detectors	29 Cu Copper	32 Ge Germanium	14 Si Silicon	11 Na Sodium	70 Yb Ytterbium
-----------------------	---------------------------	------------------------------	----------------------------	---------------------------	------------------------------

International Linear Collider (Next gen collider)	50 Sn Tin	26 Fe Iron	47 Ag Silver	29 Cu Copper
--	------------------------	-------------------------	---------------------------	---------------------------

Medical isotopes	71 Lu Lutetium	27 Co Cobalt	39 Y Yttrium
	6 C Carbon	42 Mo Molybdenum	

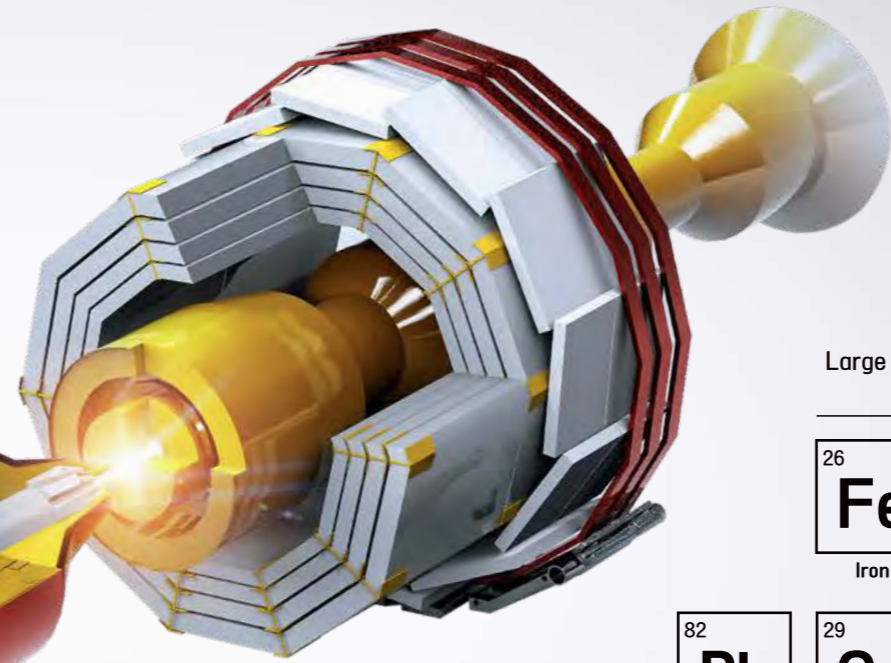
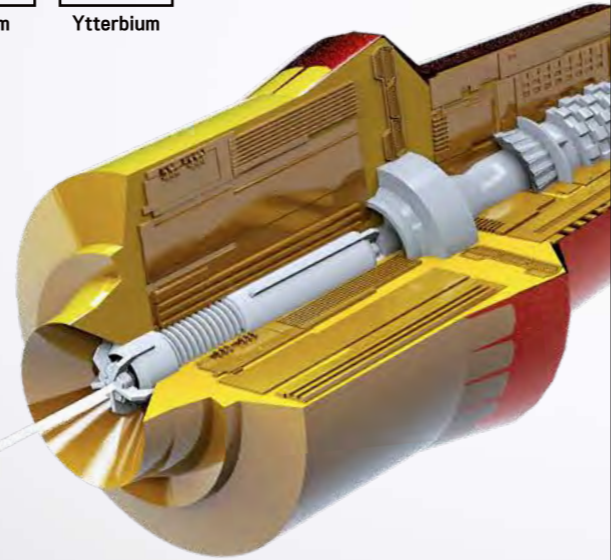

Large Hadron Collider

26 Fe Iron	41 Nb Niobium	
82 Pb Lead	29 Cu Copper	74 W Tungsten
50 Sn Tin	22 Ti Titanium	13 Al Aluminium
79 Au Gold	66 Dy Dysprosium	14 Si Silicon



The Large Hadron Collider consists of a 27 kilometre ring of superconducting magnets in an underground tunnel near Geneva, Switzerland _

CERN

27

Particle physics

Particle physics is the study of sub-atomic particles and their properties. Particle physicists use machines called accelerators to propel subatomic particles at close to light speed - and then wait for the collision. What happens to these particles on collision helps physicists understand the physical laws that govern everything from matter and energy to space and time. But those at the helm of the world's biggest science experiments are consumed with more than just the origins of the universe (i.e. the Big Bang theory). Practical particle acceleration discoveries have delivered us everything from real time security scanning at airports to the diagnosis and treatment of certain cancers, and even shrink wrap!

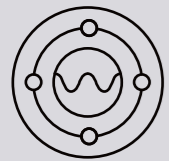

Shining light on dark matter

Stawell Gold Mines is an unlikely partner in the global search for dark matter. An international team of scientists aim to unlock the secrets of the universe, and advance cutting-edge technologies, from an underground laboratory at the mine - the first of its kind in the southern hemisphere.

From the internet to drones to GPS, the defence ecosystem has incubated some of the world's most recognisable technology _



Naval sonar

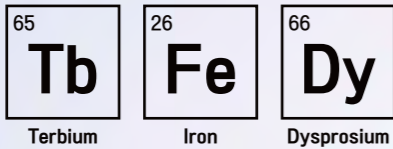

Drone aircraft

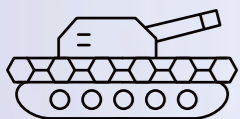
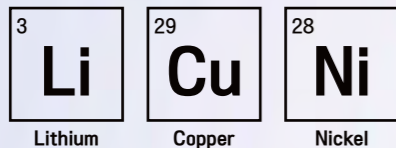

Invisibility cloak

Military vehicles fitted with BAE Systems' ADAPTIV technology can navigate enemy territory invisible to infrared systems. The futuristic honeycomb-shaped tech uses temperature to match the vehicle's thermal signature with its surrounds, and can even disguise itself to look like a cow, or a car.

Satellite communications

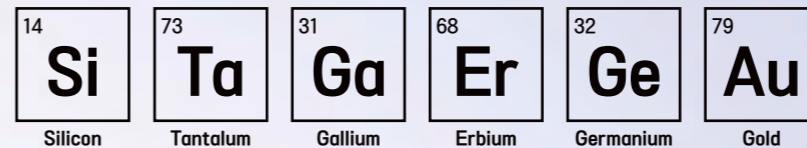
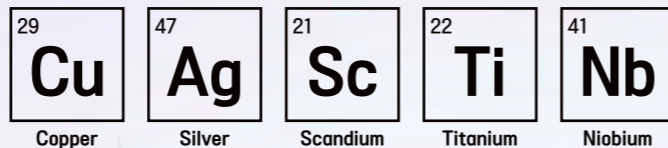

Cyber security

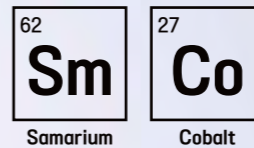

Missile defence system

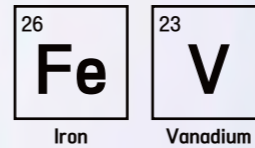
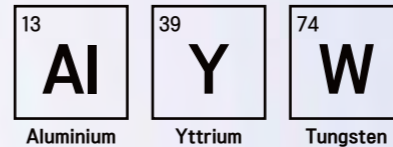

Armoured personnel carrier

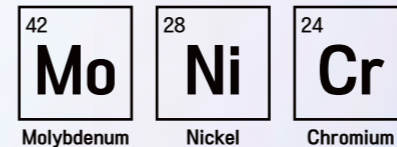

28

Defence systems

Rapid advances in robotics, AI and IoT will shape and reshape modern warfare this century. From unmanned vehicles to hypersonic missile defence systems to cyber warfare, the future of combat is hybrid in both the physical and digital realms. While military nations race to develop next gen tech - whether that be direct energy munitions, robotic armies (as horrifying as that prospect is) or even space munitions - governments are grappling with supply security of rare earth elements and other strategic minerals. The opportunity for Australia's resources is vast. Let's just hope that common interest and diplomacy are the first tools out of the defence kit to resolve future conflicts.

Sensor pods, called 'dragon eggs', have been developed that can be drone-dropped onto active volcanos to provide real-time monitoring of volcanic activity -

University of Bristol

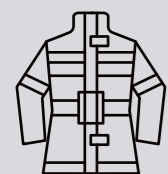
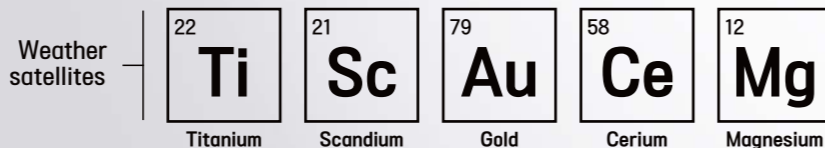
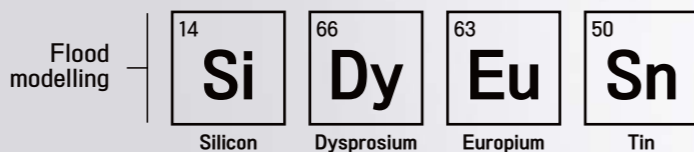
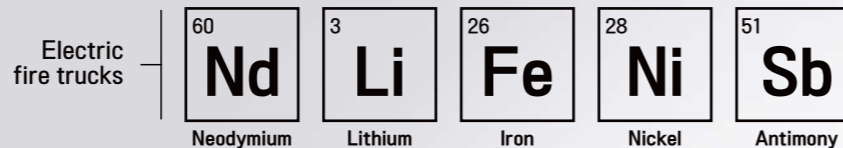

Firefighting kit

Australia scientists have developed a fire retardant nanomaterial that could revolutionise firefighting uniforms, and one day even protect vehicles and buildings. The lightweight compound, made from titanium carbide, is the product of collaborative effort of ANSTO and the University of NSW.

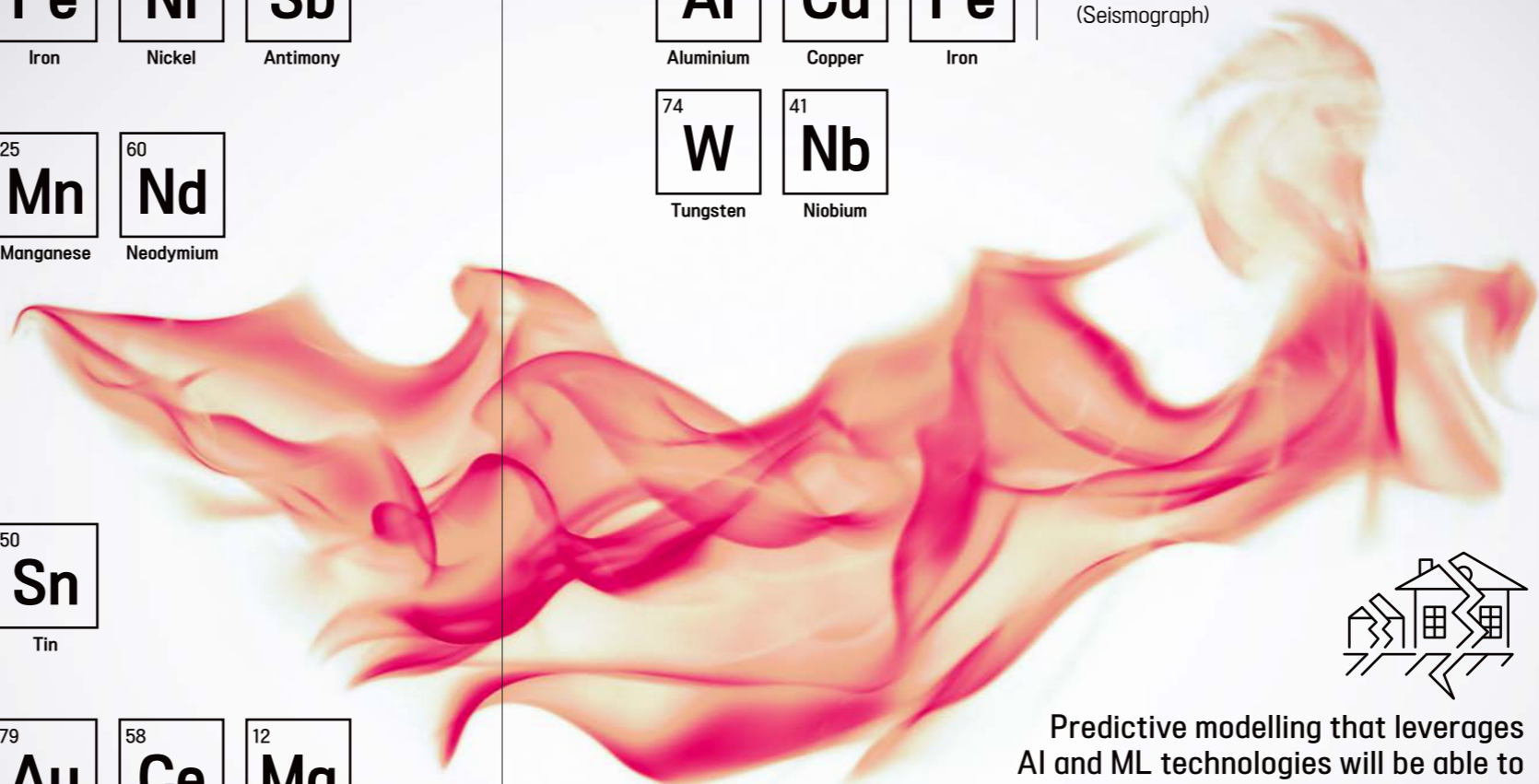
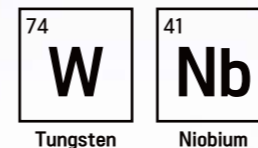
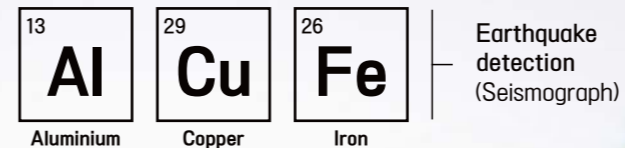

Predictive modelling that leverages AI and ML technologies will be able to better forecast low level tectonic motion before earthquakes -

Cornell University

29

Emergency management

Floods, bushfires, cyclones... natural disasters and extreme weather events exacerbated by climate change are testing populations around the world. From drones to GIS to IoT, technology is transforming the way frontline services coordinate to keep rescue personnel and communities safe. Predictive technologies leveraging AI and ML are used to forecast and simulate everything from earthquakes to heatwaves to flood events, while digital identity and facial recognition are increasingly being used to help survivors get back on their feet. In the future, sonic extinguishers may become part of the firefighter's arsenal - drone-delivered loud noises that use sound waves to disrupt and deny bushfires oxygen.

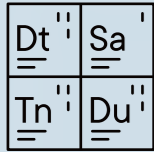

There were 246 elements known to Federation science in the 24th century. That's 128 more elements than exist on the periodic table today _

Star Trek: Voyager

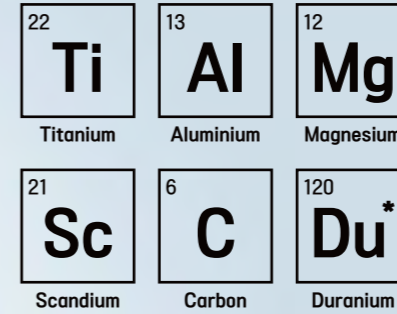
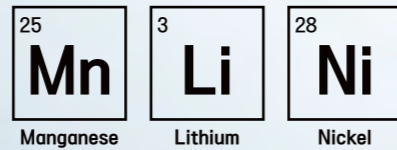
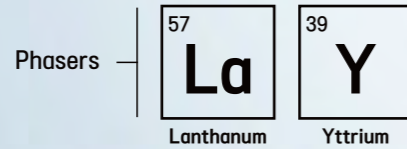
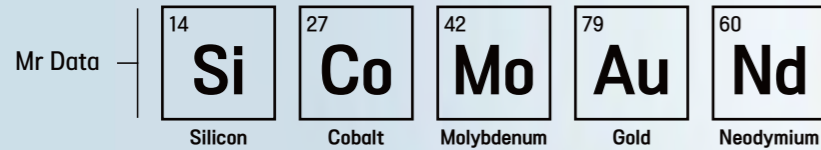
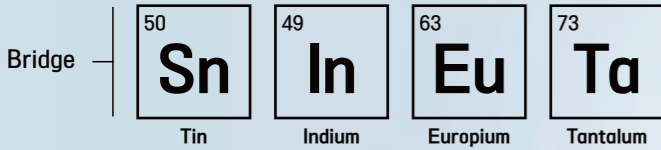

USS Enterprise (Hull)

Warp propulsion is not completely beyond the realm of possibility with a team from NASA examining faster-than-light future intergalactic travel _

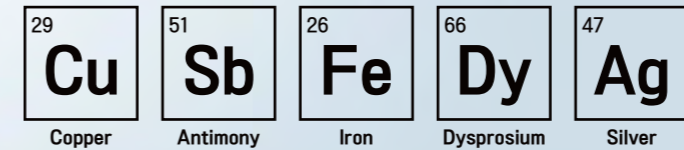
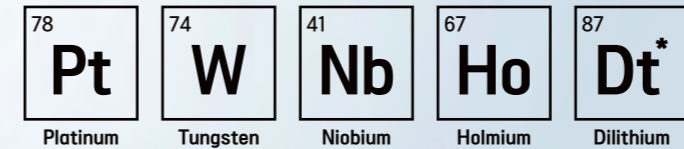

* Dilithium and duranium are invented materials in the *Star Trek* fictional universe

30

USS Enterprise

Live long and prosper. It was more than 50 years ago that Spock's immortal words captured the imaginations of sci-fi buffs everywhere, and Star Trek is still going strong today. Incredibly, many of the science fiction offerings from the enduring tv series are now a reality - from wireless communication to computer tablets and even universal translators. Numerous attempts have been made by fans to reproduce some of the advanced technologies (holodeck, anyone?), but one of the limitations is that many of the materials described in the show are yet to be discovered or produced. There is hope though - while we might not have dilithium crystals, scientists have managed to engineer transparent aluminium.

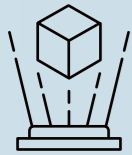

Alternate realities

Transporting ourselves into alternative realities via a holodeck is many moons away. Truly interactive holographic projections defy the laws of physics, which is a close to insurmountable problem. For impatient tech heads, the nearest approximation might eventually be found in the metaverse.



Rock stars of the future

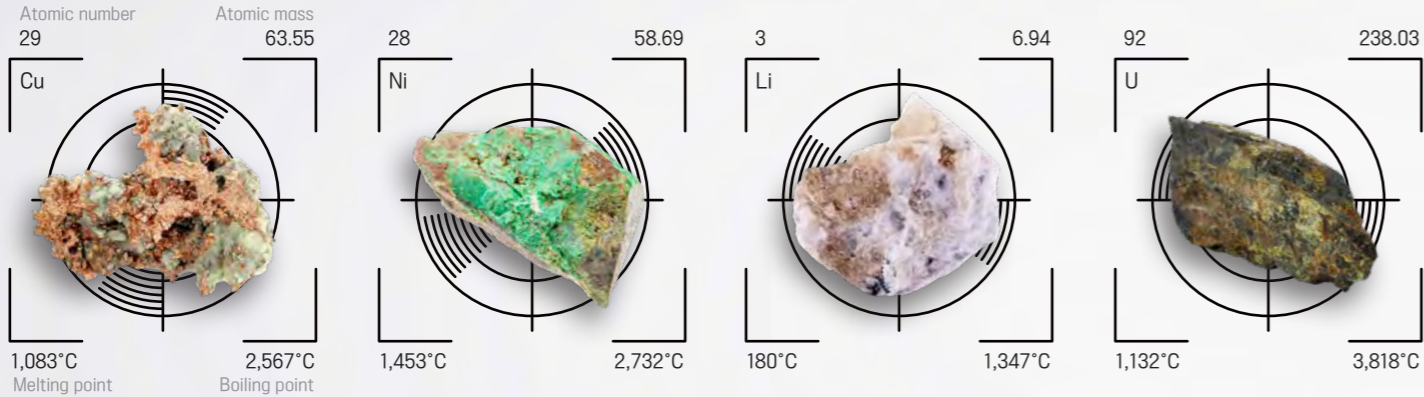

Copper

World copper consumption has doubled on average every 25 to 30 years as a result of increased access to electricity, growing incomes and rapid advancements and take up of new technologies. This pattern will accelerate with copper-intensive goods and energy infrastructure set to play an increasing role in the global economy.

Nickel

The market use of nickel will diversify over the next decade from high-grade steel required for skyscrapers and transportation networks to meet global demand for battery-grade nickel. The battery industry's market share of nickel consumption will rise to 26 per cent by 2030, according to analysts at Commodity Insights.

Lithium

The main driver of the forthcoming surge in demand for lithium ion batteries will be car manufacturers releasing more electric vehicle models and the rising use of renewable energy requiring greater use of energy storage technology. Commodity Insights forecasts growth in lithium demand of 368 per cent to 2030.

Uranium

More than 30 countries rely on low cost, zero emissions nuclear-generated electricity to underpin baseload power requirements and tackle climate change. Commodity Insights forecasts global uranium demand to rise to 99.5 kt in 2030, driven largely by China, which has outlined plans to significantly increase nuclear generation.

Global demand for clean energy technologies could push production of future-critical minerals nearly 500 per cent higher by 2050



World Bank Group

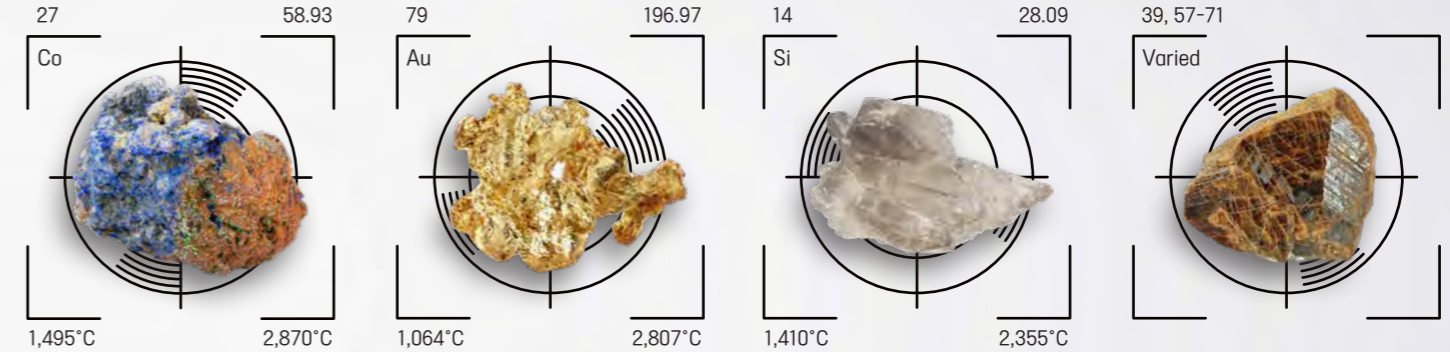

Cobalt

Cobalt is an important material in the cathode of many lithium-ion batteries as it boosts energy density and extends battery life. Rapid growth in the production of electric vehicles over the next ten years is set to significantly increase global demand for cobalt and will require new mines around the world to open.

Gold

Gold has provided top notch investment returns over the past 20 years and looks set to hold its position for superior long-term returns compared to bonds and other asset classes given uncertain economic times. Its role in financial systems continues to grow with central banks and exchange traded funds increasing their holdings.

Silicon

Often overlooked, silicon is the most consumed mineral commodity in the world. It is used to make concrete, glass, solar panels and importantly, the micro processors that power high tech consumer electronics. Rising urbanisation, solar PV production and emerging technologies will drive higher consumption of silicon.

Rare earth elements

Demand growth is expected for most rare earth elements over and beyond the next decade, mainly supported by the manufacture of permanent magnets used in offshore wind turbines and the drive trains of most EVs. The IEA forecasts global neodymium demand to increase between 73 per cent and 113 per cent to 2030.



Workhorses of the future

THE FUTURIST EDITION



Iron_

Rising urbanisation rates and industrial expansion across Asia will drive growing steel demand into the future. The stock of steel in these highly populated Asian economies remains less than half that of OECD nations. High-grade iron ore, such as ores mined in Australia, produce fewer emissions during the steel-making process.

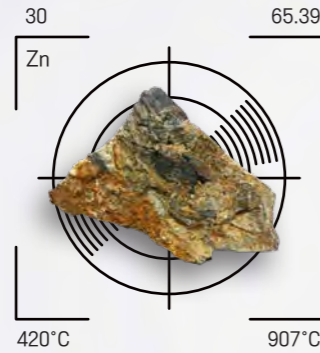

Zinc_

Zinc's primary use is galvanising steel to prevent rust from forming and its outlook is therefore linked to the fortunes of steel. Industrial expansion - the construction of bridges, factories, high-rise buildings and ships - will see zinc consumption rise 12 per cent to 2030, according to Commodity Insights.



Manganese_

From the steel used in railway lines to the aluminium packaging in soft drink cans, manganese alloys are all around us. Manganese is also an important cathode material in electric vehicle batteries and grid storage devices. Manganese demand will rise as production capacity increases in Asia, Europe and North America.



Molybdenum_

Molybdenum is a critical component of the steel used to make railway lines. Mass urbanisation in developing economies will accelerate demand for the ductile and corrosion-resistant metal. 'Moly steel' alloys are also used in parts of engines, heating elements and saw blades where strength and hardness are important.

Rising urbanisation and industrial expansion in emerging economies across Asia will drive demand for steel and its alloys_

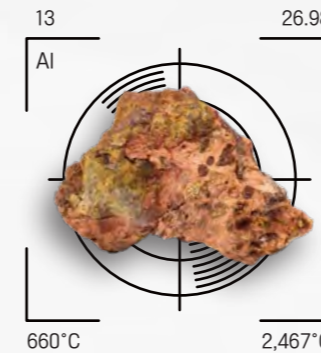

Aluminium_

World consumption of aluminium has increased substantially over the last 20 years, underpinned by rapid demand from higher incomes, rising urbanisation and greater car ownership in Asia. Commodity Insights forecasts primary aluminium demand to rise rapidly to 94.7 Mt by 2030, representing overall growth of 45.5 per cent.

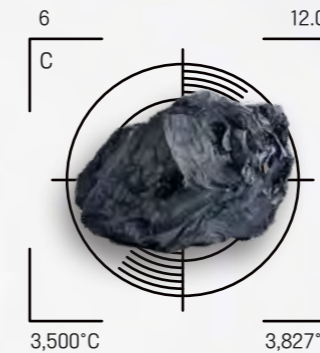

Metallurgical coal_

Steel demand for new high density housing, transport infrastructure and industrial machinery in emerging economies will see demand for metallurgical coal rise steadily to 2030, according to Commodity Insights. Global steel production is dependent on high quality metallurgical coal, with around 70 per cent of steel produced using coal.



Chromium_

Chromium is the essential alloying agent of stainless steel. Used in leather tanning, printing and catalysts, it is highly resistant to corrosion, even at high temperatures, and reflects about 70 per cent of light making it a fan-favourite with consumers. Much more than a one-trick pony, chromium is also used to colour ceramics and paint.

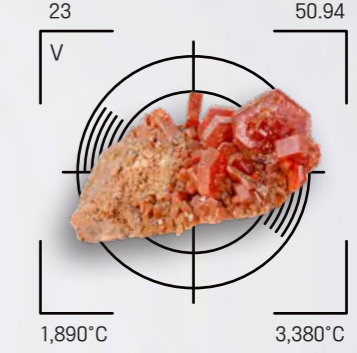

Vanadium_

Strength is the primary characteristic of vanadium, commonly used in steel alloys in nuclear reactors, space vehicles and aircraft carriers. The demand outlook for vanadium is expected to grow, particularly if the vanadium-flow battery, touted for its large-scale energy storage potential, gains momentum.

Mining makes the *imaginable* possible



Download PDF



Download PDF



things

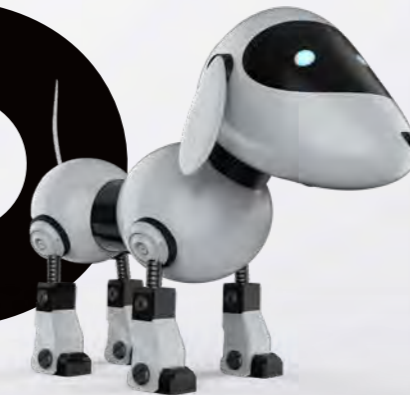

THE *Futurist* EDITION

Minerals Council of Australia

Phone. +61 2 6233 0600

Email. info@minerals.org.au

While every effort has been made to ensure the accuracy and completeness of information contained within, no guarantee is given nor responsibility taken for errors or omissions. This publication is intended for general and educational use and should not be relied on for scientific or business purposes.

September 2022

© Minerals Council of Australia

minerals.org.au





30
things